

CHAMPION

BIG ON QUALITY. CHAMPION ON PRICE!

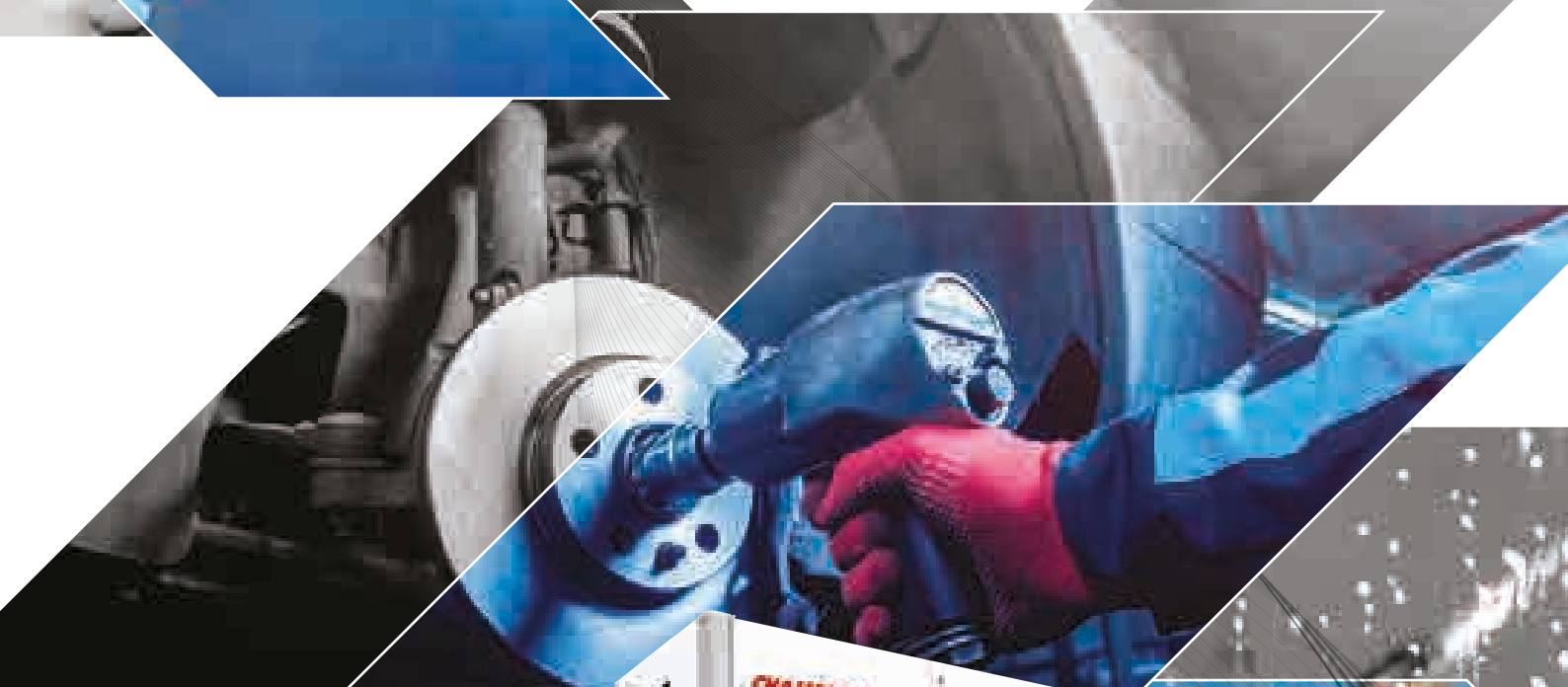

February 2023

www.ChampionAirtech.com

CONTENTS

SCREW COMPRESSORS 2.2 - 132kW	4 - 35
FM Series 2.2 - 7.5kW	6 - 9
FM Fixed Speed - FM RS Variable Speed Series 7.5 - 22kW	10 - 23
FM Fixed Speed - FM RS Variable Speed Series 30 - 75kW	24 - 31
FM Fixed Speed - FM RS Variable Speed Series 90 - 132kW	32 - 35
SEQUENCE MULTIPLE COMPRESSORS	36 - 39
AIRINSITE	40 - 41
PISTON COMPRESSORS	42 - 53
RECIPROCATING CAST IRON COMPRESSORS	54 - 57
ROTARY AIR VANE COMPRESSORS	58 - 61
SCROLL COMPRESSORS	62 - 69
DENTAL COMPRESSORS	70 - 75
BREATHING AIR COMPRESSORS	76 - 81
PORTABLE SCREW COMPRESSORS	82 - 87
COMPRESSED AIR TREATMENT	88 - 129
Compressed Air Filters	92 - 97
Filter Elements	98 - 99
Refrigeration Compressed Air Dryers	100 - 101
Modular Desiccant Dryers	102 - 103
Heatless Desiccant Dryers	104
Membrane Dryers	105
Air Cooled Aftercoolers	106 - 107
Activated Carbon Towers	108 - 109
Compressed Air Equipment	110 - 111
Breathing Air Filter	112 - 113
Breathing Air Filter Plus	114 - 115
Heat Recovery Units	116
Vertical Air Receivers	117 - 118
Condensate Drains	120 - 123
Oil/Water Separation Equipment	124 - 125
Industrial Chillers	126 - 127
EPL Piping System	128 - 129
AFTERMARKET	130 - 150
FM02 - FM06 Service Schedule	133
FM07 - FM22 Service Schedule	134
FM30 - FM132 Service Schedule	135
Vane Compressors Service Schedule	136
Scroll Compressors Service Schedule	137
Portables Service Schedule	138
Piston Compressors Service Schedule	139
Compressor Service Kits	140 - 141
Dryer Service Kits	142 - 145
Activated Carbon Tower Service Kits	146
Filter Guide	147 - 149
Service Kits For Legacy Products	150





FIXED & VARIABLE SPEED



SCREW COMPRESSORS

2.2 - 132kW

- Oil flooded
- Single stage rotary screw compressor
- Fixed and variable speed models
- Star / Delta starting
- Pressure range 5 - 13 bar
- Electric motor 2.2kW to 132kW - IE3
- Modular design including receivers and dryers
- C-PRO 1.0+, C-PRO 2.0 & Pilot TS
- Extended warranties available





SMART COMPRESSOR DESIGN

At a glance...



Nominal Pressure
10 bar g



Motor Power
2.2 - 7.5kW



Volume Flow
0.18 - 0.9 m³/min



FM Series

Well known in the industry for quality and reliability, Champion continuously develops the FM Series to achieve cutting edge performance and efficiency.

The FM02-FM06 range of lubricated screw compressors comprises of many different models and versions to allow maximum flexibility.

Engineering excellence

Compressors are more than just a financial investment, they are a key component in ensuring that manufacturers, processors and operators receive consistent, high quality low cost air. The screw compression element is the heart of the compressor and therefore Champion keeps the design and manufacture in-house, using the latest CNC rotor grinding machinery, coupled with online laser technology.

The resulting reliability and performance ensure that operating costs will remain low throughout the compressor's life.



Engineered for total piece of mind

Thanks to the user-friendly design, these compressors are easy to use, easy to install and fully ready for plug and play. Designed with a minimum number of moving parts, the compressors are very reliable, robust and capable to run continuously. The new canopy design of the compressors guarantees a quick and easy maintenance, minimising the downtime and maximising the reliability.



Maximum flexibility

Based on the individual customer requirements the compressors can be combined with different options to provide everything from a stand alone compressor to the complete airstation.

The options include:



Compressor base mounted



Receiver mounted compressor



Complete airstation including compressor, dryer and receiver

New C-Pro1.0+ User-friendly control system

The new compressor controller C-Pro1.0+ is equipped as standard for all models and provides information about pressure, oil temperature and compressor status (load/unload) together in one display and offers many useful features, such as:

- Communication port RS485 supporting Modbus
- Integrated sequencer for easy control for 2 compressors
- Plastic box for higher IP protection degree
- Auto restart after black-out
- Password protection
- Air and oil filter replacement
- Separator filter replacement and oil change
- Pressure setting easily adjustable
- Unload timer for both DOL & SDS

Optional equipment

- Receivers available at 270lt and 500lt for FM04-FM06
- Prefilter and microfilter combination
- Timed or float drains for receiver mounted units and airstation

FM SERIES



Compact & Flexible

Reliable electric motor

IP55, F-class insulation, IE3 class

Safety devices for

- Motor over temperature
- Compressor over temperature
- Aired rotation

Receiver mounted

High quality receiver built to EN87/404 (AD2000)

Airstation

Equipped with high performance dryer featuring intelligent control system for low pressure losses.

- Pressure dew point +3°C (ISO 7183, A)
- Environmentally friendly refrigerant R134a
- Digital controller displaying:
 - Dew point indication
 - Additional energy saving mode
 - Maintenance display
 - Fault memory

Small footprint

The compressor itself requires a minimum floor space of only 62 x 60 cm, with the receiver mounted models being exceptionally space-saving.

4 - 7.5kW extended features

- Star Delta starter is included as standard from 4 up to 7.5kW
- 5.5 + 7.5 kW variants have an optional after cooler available to optimise air quality and minimise the size of downstream needed

flexiDry

CHR series refrigeration air dryers

The advanced design and innovative technology offered by CHR Series refrigeration dryers provides an optimised performance alongside a more efficient mode of management.

The electronic controller, complete with user-friendly interface, has been simplified to focus on the essential functions of operation and regulation, including the unique fan control (CHR6 – CHR167).

Simplicity in design, unrivalled reliability, and extraordinary value for money are the core strengths of this new family of units.



Maintenance is as easy as ever

Fast and easy service

These compressors are designed to ensure easy access to maintenance points. All cabinet panels can be easily removed to allow full access to all service points. Also, the limited number of moving parts reduces service costs.

Technical data

FM 2–6 Series: Screw Compressors

Design: Oil flooded, single stage rotary screw compressor, belt drive, direct start or star / delta starting

Pressure Range: 10 bar

Electric motor: 2.2 to 7.5kW – IE3



FM SERIES CODE	TYPE	FM2 230V RSCCP020601	FM2 RSCCP020602	FM3 RSCCP020603	FM4 RSCCP020604	FM5 RSCCP020605	FM6SDS RSCCP020608
Maximum pressure	bar	10	10	10	10	10	10
Capacity at maximum pressure	m ³ /min	0.18	0.21	0.35	0.45	0.66	0.92
Drive motor IP 55 / class F – IE3	kW	2.2	2.2	3	4	5.5	7.5
Operating voltage, 50Hz, 60Hz	400V	•	•	•	•	•	•
C-Pro 1.0+ electronic controller		•	•	•	•	•	•
Noise level	dB(A)	63	63	64	67	68	70
Air cooled		•	•	•	•	•	•
Weight	kg	151	151	151	154	168	174
Dimensions [L x W x H]	mm	622 x 599 x 1106					
Outlet connection		½"	½"	½"	½"	½"	½"
STD. COMPRESSOR SDS							
Code		–	–	–	RSCCP020606	RSCCP020607	–
SDS Starter		–	–	–	•	•	–
Noise level	dB(A)	–	–	–	70	68	–
COMPRESSOR MOUNTED ON 270 LT TANK							
Code		RSCCP020610	RSCCP020611	RSCCP020612	RSCCP020613	RSCCP020614	–
Weight	kg	242	242	242	245	258	–
Dimensions [L x W x H]	mm	1539 x 720 x 1604					
COMPRESSOR MOUNTED ON 270 LT TANK SDS							
Code		–	–	–	RSCCP020615	RSCCP020616	RSCCP020617
Weight	kg	–	–	–	245	258	264
Dimensions [L x W x H]	mm	–	–	–	1539 x 720 x 1604		
COMPRESSOR MOUNTED ON 500 LT TANK							
Code		–	–	–	RSCCP020620	RSCCP020621	–
Weight	kg	–	–	–	314	318	–
Dimensions [L x W x H]	mm	–	–	–	1885 x 720 x 1700		
COMPRESSOR MOUNTED ON 500 LT TANK SDS							
Code		–	–	–	RSCCP020622	RSCCP020623	RSCCP020624
Weight	kg	–	–	–	314	318	334
Dimensions [L x W x H]	mm	–	–	–	1885 x 720 x 1700		
PACKAGE VERSION, FM / CT / 270							
Code		RSCCP020630	RSCCP020631	RSCCP020632	RSCCP020633	RSCCP020634	–
Weight	kg	261	261	261	270	284	–
Dimensions [L x W x H]	mm	1539 x 720 x 1604					
PACKAGE VERSION, FM / CT / 270 / SDS							
Code		–	–	–	RSCCP020635	RSCCP020636	RSCCP020637
Weight	kg	–	–	–	270	284	290
Dimensions [L x W x H]	mm	–	–	–	1539 x 720 x 1604		
PACKAGE VERSION, FM / CT / 500							
Code		–	–	–	RSCCP020640	RSCCP020641	–
Weight	kg	–	–	–	339	353	–
Dimensions [L x W x H]	mm	–	–	–	1885 x 720 x 1700		
PACKAGE VERSION, FM / CT / 500 / SDS							
Code		–	–	–	RSCCP020642	RSCCP020643	RSCCP020644
Weight	kg	–	–	–	339	353	359
Dimensions [L x W x H]	mm	–	–	–	1885 x 720 x 1700		
OPTIONAL							
Alternative Voltage 230/3/50-60Hz		CONFIG_F0_F1_230_VOLT					
Alternative Voltage 380/3/60Hz		CONFIG_F0-F4_380_VOLT					
Factory Fitted Filter Kit including By-Pass 2.2-3 kW		CONFIG_F0_FILTER1					
Factory Fitted Filter Kit including By-Pass 4-5.5 kW		CONFIG_F0_FILTER2					
Factory Fitted Filter Kit including By-Pass 7.5 kW		CONFIG_F0_FILTER3					
Retro Fit Filter Pack with By-Pass 2.2-3 kW		CC1219584					
Retro Fit Filter Pack with By-Pass 4-5.5 kW		CC1219585					
Retro Fit Filter Pack with By-Pass 7.5 kW		CC1219586					
Factory Fitted Automatic Drain (only with factory fitted filter option)		CONFIG_F0_F2_DRAIN					
Factory Fitted After Cooler		CONFIG_F0_COOLER					
AD2000 (internal separator vessel)		CONFIG_F0-F4_AD2000					
Factory Fitted Food Grade Oil		CONFIG_F0_FOODGRADE					
SERVICE KITS							
Standard Service Kit FM2-6		CC1219905					
Advanced Service Kit FM2-6		CC1219906					
Major Service Kit FM2-6		CC1219907					
ChampLube Screw Lubricant 4 Ltr (x4)		CC1180019					
AEON SCFG 8000 5 Ltr		ZS1216903					
AEON SCFG 8000 20 Ltr		ZS1216945					
AEON SCFG 8000 208 Ltr		ZS1216946					

For models with After Cooler option add 5kg to the weight

FM FIXED SPEED, FM RS VARIABLE SPEED

COMPACT & RELIABLE ROTARY SCREW COMPRESSORS - FM SERIES

At a glance...

-  **Nominal Pressure**
5 - 13 bar g
-  **Motor Power**
7 - 22kW
-  **Volume Flow**
0.45 - 3.50 m³/min

FM & FM RS Screw Compressors up to 46°C ambient temperature

The generously sized ventilation system ensures optimum cooling, low outlet air temperatures best performance and reliability under harshest conditions

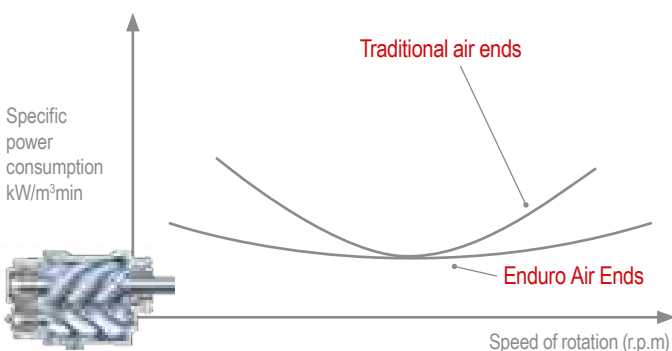

Premium Quality Airends

FM series feature high quality airends manufactured in Finland using state of the art manufacturing techniques. The airends are designed with focus on reliability and efficiency. The rotors are accurate and thoroughly checked and measured by a computerised control system. Enduro airends have a flat specific power consumption curve, which enables efficient use of the airend in wide rpm. For models FM15-22 the Tamrotor Enduro airend features integrated air - oil separator and oil filter which offers a very compact design and improved maintenance.



FM & FM RS package compressors with dryer and tank

Based up on the individual customer requirements the compressors can be combined with different options to provide options from a stand alone compressor to the complete package.

- Compressor base mounted
- Tank mounted compressor
- Complete package including compressor, dryer and tank

New advanced controller C-PRO 2.0 ensures reliable operation and protects your investment by continuously monitoring the operational parameters

- ✓ 3 analogue inputs
- ✓ Multi-language: English/German/French/Italian/Spanish
- ✓ Standard sequence control up to 8 units
(up to 7 units fixed speed & 1 variable speed)
- ✓ Standard Modbus
- ✓ 15 failure records in memory
- ✓ Continuous system monitoring





Easy maintenance

FM compressors are designed to ensure easy access to maintenance points. Panels on the structure can be easily removed to allow full access to all service points. Also, the limited number of moving parts reduces service costs.

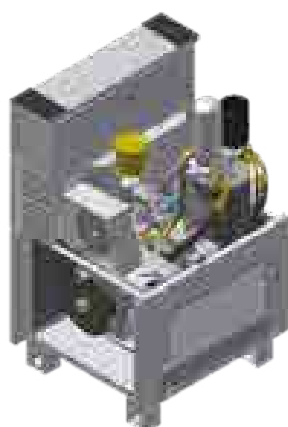

The automate tensioning of the belt assures long life of the belt, less maintenance and noise reduction.



Belt Auto Tensioning system



Compact design with a footprint of 0,4 m² for frame 1 and 0.5m² for frame 2; FM series offer one of the most compact air compressors in the market. FM innovative design also features low noise level allowing installation at the point of use.

High Efficient Motors

- ✓ International efficiency class 2 (IE3) as a standard.
- ✓ IP 55 enclosure
- ✓ Full performance up to 46°C ambient temperature

FM FIXED SPEED, FM RS VARIABLE SPEED

FM RS



= Energy savings and lower CO₂ emissions into the environment.



The variable speed compressor: One smart solution

Variable speed compressors can efficiently and reliably handle the varying air demand found in most plant air systems. These compressors speed up and slow down to match air supply to air demand as it fluctuates. The right variable speed compressor in the right application delivers significant energy savings and a stable, consistent air supply.

Compressor energy cost example

NOMINAL kW	OPERATING COST PER YEAR (5000 HOURS) AT COST PER KWH (€)					
	0.06	0.08	0.10	0.12	0.14	0.16
15	4,495	5,990	7,490	8,985	10,483	11,980
18	5,540	7,390	9,235	11,080	12,930	14,775
22	6,590	8,785	10,980	13,180	15,375	17,570

Note: Hours of operation based on two 8hrs-shifts, 6 days per week. Calculations based on nominal kW.

Cost of compressed air over 5 years

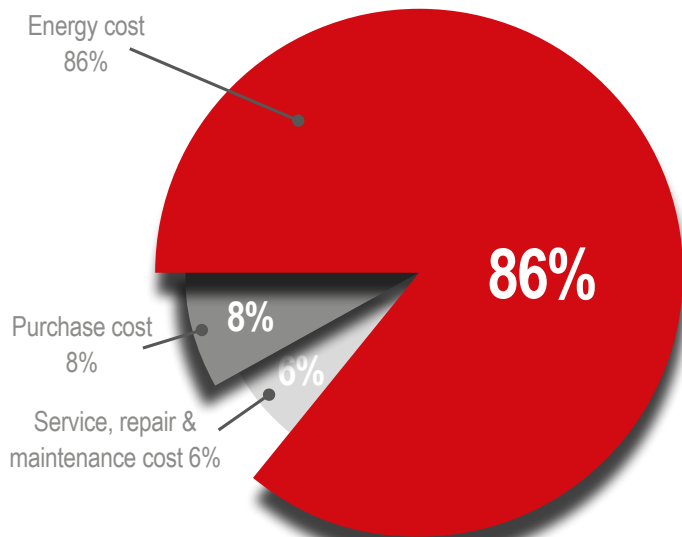

FM-RS Series features Power Drive Systems that exceed the class IES2 EN61800-9 requirements and assure high efficiency and high energy savings levels.



Allows substantial energy savings of at least 25% of the energy cost

FM package compressors

With dryer, filters and tank

The FM Package compressors can be easily and rapidly installed in any installation.

The intelligent C-PRO 2.0 controller

Simplicity

The C-PRO 2.0 controller was designed to make the operators' interface with the variable speed drive transparent. This new generation controller features extra functions for variable speed compressors like drive status display and flexible PID setting according to the application. You don't need to be an expert on variable speed drives to operate your compressor. The controller takes care of the details and automatically adjusts the compressor performance to meet your changing air system demands - saving you energy. Changing the discharge pressure is as easy as pressing a button.



ELITE SERIES

The Complete Package

At a glance...



Nominal Pressure
10 bar



Motor Power
7.5 and 11kW



Volume Flow
0.97 to 1.39 m³/min



The **Champion ELITE Series** is a true “plug & play” compressed air station providing clean, dry air from a complete package.

The **ELITE Series** includes a rotary screw compressor mounted onto a horizontal tank, refrigerated dryer, filtration pack, automatic condensate drain and an oil/water separator.

For total peace of mind, all essential components including a serviceable oil/water separator have been assembled into a single unit. Not only do you save on space and installation costs, but you don't need to worry about the responsible disposal of oil contaminated condensate either.

Available with either a 7.5kW or 11kW efficient IE3 motor and new C-Pro-2 electronic controller as standard, these rotary screw compressors packages offer a pressure rating of 10 bar on a 270 litre horizontal receiver. Both models are designed with a focus on reliability and efficiency and are built around the high quality air ends designed and manufactured in-house in Finland. Panels can be easily removed for access to all service parts ensuring ease of maintenance.

ELITE – “plug & play” simplicity from Champion.



CHR Series Refrigerated Dryer

- Optimised performance and efficient mode of management
- User-friendly electronic controller
- Separate power supply
- Simplicity in design and unrivalled reliability



Oil/Water Separator

- Environmental friendly disposal of condensate – complying with local environmental laws
- Multi-stage separation
- Exceptional performance and trouble free operation
- Fully serviceable



CHF Filter Package

- CHF Cyclonic Separator – water and liquid oil removal
- CHF Grade M Filter – particulate to 0.1 microns and oil aerosol to 0.03mg/m³
- CHF Grade S Filter – particulate to 0.01 microns and oil aerosol to 0.01mg/m³



Condensate Drains

- Reliable drain system
- Robust and designed for long life industrial applications
- Direct acting valve construction with large orifice
- Stainless steel moving parts offering an extended life guarantee

FM FIXED SPEED, FM RS VARIABLE SPEED

Technical data

FM 7 Series: Screw Compressors

Design: Oil flooded, Single stage rotary screw compressor, belt drive, air cooled

Pressure Range: 7-8-10-13 bar

Electric motor: 7.5 kW - IE3



FM SERIES CODE	TYPE	FM7			
		CC1184130	CC1184131	CC1183626	CC1184132
Maximum pressure	bar	7	8	10	13
Capacity at maximum pressure	m ³ /min	1.14	0.99	0.97	0.80
Drive motor IP 55 / class F – IE3	kW	7.5	7.5	7.5	7.5
Operating Voltage, 50Hz	400 V	•	•	•	•
Control voltage	24 V	•	•	•	•
C-Pro 2.0 electronic controller		•	•	•	•
Noise Level	db(A)	70	70	70	70
After-cooler		•	•	•	•
Weight	kg	205	205	205	205
Dimensions (LxWxH)	mm	667x630x1050	667x630x1050	667x630x1050	667x630x1050
Outlet connection EN 10266 (DIN 2999)		3/4"	3/4"	3/4"	3/4"
COMPRESSOR MOUNTED ON 270 LT TANK					
Code		RSCCP0709	RSCCP0710	RSCCP0711	RSCCP0712
Weight	kg	300	300	300	300
Dimensions (LxWxH)	mm	1600x700x1600	1600x700x1600	1600x700x1600	1600x700x1600
COMPRESSOR MOUNTED ON 500 LT TANK					
Code		RSCCP0713	RSCCP0714	RSCCP0715	RSCCP0716
Weight	kg	365	365	365	365
Dimensions (LxWxH)	mm	2000x700x1700	2000x700x1700	2000x700x1700	2000x700x1700
PACKAGE VERSION, FM / CT / 270 ¹⁾					
Code		RSCCP0725V4	RSCCP0726V4	RSCCP0727V4	RSCCP0728V4
Weight	kg	340	340	340	340
Dimensions (LxWxH)	mm	1600x700x1600	1600x700x1600	1600x700x1600	1600x700x1600
PACKAGE VERSION, FM / CT / 500 ¹⁾					
Code		RSCCP0729V4	RSCCP0730V4	RSCCP0731V4	RSCCP0732V4
Weight	kg	405	405	405	405
Dimensions (LxWxH)	mm	2000x700x1700	2000x700x1700	2000x700x1700	2000x700x1700
OPTIONAL					
Alternative Voltage, 230V / 50-60 Hz		CONFIG_F0_F1_230_VOLT			
Alternative Voltage, 380V / 60 Hz		CONFIG_F0-F4_380_VOLT			
Factory Fitted Filter Kit including By-Pass 7.5 kW		CONFIG_F1_FILT1			
Factory Fitted Filter Kit including By-Pass 11 kW		CONFIG_F1_FILT2			
Retro Filter Kit including By-Pass 7.5-11 kW for 270 Litre Receiver		CC1201969			
Retro Filter Kit including By-Pass 7.5-11 kW for 500 Litre Receiver		CC1201970			
Factory Fitted Automatic Drain		CONFIG_F0_F2_DRAIN			
AD2000 (internal separator vessel)		CONFIG_F0-F4_AD2000			
Factory Fitted Food Grade Oil		CONFIG_F1_FOODGRADE			
Extended 5 year warranty		CC1180791			
SERVICE & PARTS					
Service Kit for every 2000 h or 12 months		CC1221491			
Annual Kit FM07-11		CC1180671			
Advanced Service Kit FM07-11		CC1180677			
ChampLube Screw Lubricant 4 Ltr (x4)		CC1180019			
AEON SCFG 8000 5 Ltr		ZS1216903			
AEON SCFG 8000 20 Ltr		ZS1216945			
AEON SCFG 8000 208 Ltr		ZS1216946			

FM 11 Series: Screw Compressors

Design: Oil flooded, Single stage rotary screw compressor, belt drive, air cooled

Pressure Range: 7 to 13 bar

Electric motor: 11 kW - IE3



FM SERIES CODE	TYPE	FM11			
		CC1184133	CC1184154	CC1183627	CC1184155
Maximum pressure	bar	7	8	10	13
Capacity at maximum pressure	m ³ /min	1.59	1.58	1.39	1.14
Drive motor IP 55 / class F – IE3	kW	11	11	11	11
Operating Voltage, 50Hz	400 V	•	•	•	•
Control voltage	24 V	•	•	•	•
C-Pro 2.0 electronic controller		•	•	•	•
Noise Level	db(A)	70	70	70	70
After-cooler		•	•	•	•
Weight	kg	219	219	219	219
Dimensions (LxWxH)	mm	667x630x1050	667x630x1050	667x630x1050	667x630x1050
Outlet connection EN 10266 (DIN 2999)		3/4"	3/4"	3/4"	3/4"
COMPRESSOR MOUNTED ON 270 LT TANK					
Code		RSCCP1109	RSCCP1110	RSCCP1111	RSCCP1112
Weight	kg	314	314	314	314
Dimensions (LxWxH)	mm	1600x700x1600	1600x700x1600	1600x700x1600	1600x700x1600
COMPRESSOR MOUNTED ON 500 LT TANK					
Code		RSCCP1113	RSCCP1114	RSCCP1115	RSCCP1116
Weight	kg	379	379	379	379
Dimensions (LxWxH)	mm	2000x700x1700	2000x700x1700	2000x700x1700	2000x700x1700
PACKAGE VERSION, FM / CT / 270¹⁾					
Code		RSCCP1125V4	RSCCP1126V4	RSCCP1127V4	RSCCP1128V4
Weight	kg	354	354	354	354
Dimensions (LxWxH)	mm	1600x700x1600	1600x700x1600	1600x700x1600	1600x700x1600
PACKAGE VERSION, FM / CT / 500¹⁾					
Code		RSCCP1129V4	RSCCP1130V4	RSCCP1131V4	RSCCP1132V4
Weight	kg	419	419	419	419
Dimensions (LxWxH)	mm	2000x700x1700	2000x700x1700	2000x700x1700	2000x700x1700
OPTIONAL					
Alternative Voltage, 230V / 50-60 Hz		CONFIG_F0_F1_230_VOLT			
Alternative Voltage, 380V / 60 Hz		CONFIG_F0-F4_380_VOLT			
Factory Fitted Filter Kit including By-Pass 7.5 kW		CONFIG_F1_FILTER1			
Factory Fitted Filter Kit including By-Pass 11 kW		CONFIG_F1_FILTER2			
Retro Filter Kit including By-Pass 7.5-11 kW for 270 Litre Receiver		CC1201969			
Retro Filter Kit including By-Pass 7.5-11 kW for 500 Litre Receiver		CC1201970			
Factory Fitted Automatic Drain		CONFIG_F0_F2_DRAIN			
AD2000 (internal separator vessel)		CONFIG_F0-F4_AD2000			
Factory Fitted Food Grade Oil		CONFIG_F1_FOODGRADE			
Extended 5 year warranty		CC1180791			
SERVICE & PARTS					
Service Kit for every 2000 h or 12 months		CC1221491			
Annual Kit FM07-11		CC1180671			
Advanced Service Kit FM07-11		CC1180677			
ChampLube Screw Lubricant 4 Ltr (x4)		CC1180019			
AEON SCFG 8000 5 Ltr		ZS1216903			
AEON SCFG 8000 20 Ltr		ZS1216945			
AEON SCFG 8000 208 Ltr		ZS1216946			

FM FIXED SPEED, FM RS VARIABLE SPEED

FM 7 RS Series: Screw Compressors

Design: Oil flooded, Single stage rotary screw compressor, variable speed, air cooled

Pressure Range: 5 to 13 bar

Electric motor: 7.5 kW - IE3



FM SERIES CODE	TYPE	FM7RS			
		CC1184156	CC1184157	CC1184158	CC1184159
Maximum pressure	bar	7	8	10	13
Capacity at maximum pressure	m ³ /min	1.13	0.98	0.95	0.80
Drive motor IP 55 / class F – IE3	kW	7.5	7.5	7.5	7.5
Operating Voltage, 50Hz	400 V	•	•	•	•
Control voltage	24 V	•	•	•	•
C-Pro 2.0 electronic controller		•	•	•	•
Noise Level	db(A)	67	67	67	67
After-cooler		•	•	•	•
Weight	kg	225	225	225	225
Dimensions (LxWxH)	mm	667x630 x1050	667x630x1050	667x630x1050	667x630x1050
Outlet connection EN 10266 (DIN 2999)		3/4"	3/4"	3/4"	3/4"
COMPRESSOR MOUNTED ON 270 LT TANK					
Code		RSCCP0717	RSCCP0718	RSCCP0719	RSCCP0720
Weight	kg	320	320	320	320
Dimensions (LxWxH)	mm	1600x700x1600	1600x700x1600	1600x700x1600	1600x700x1600
COMPRESSOR MOUNTED ON 500 LT TANK					
Code		RSCCP0721	RSCCP0722	RSCCP0723	RSCCP0724
Weight	kg	385	385	385	385
Dimensions (LxWxH)	mm	2000x700x1700	2000x700x1700	2000x700x1700	2000x700x1700
PACKAGE VERSION, FM / CT / 270 ¹⁾					
Code		RSCCP0733V4	RSCCP0734V4	RSCCP0735V4	RSCCP0736V4
Weight	kg	360	360	360	360
Dimensions (LxWxH)	mm	1600x700x1600	1600x700x1600	1600x700x1600	1600x700x1600
PACKAGE VERSION, FM / CT / 500 ¹⁾					
Code		RSCCP0737V4	RSCCP0738V4	RSCCP0739V4	RSCCP0740V4
Weight	kg	425	425	425	425
Dimensions (LxWxH)	mm	2000x700x1700	2000x700x1700	2000x700x1700	2000x700x1700
OPTIONAL					
Alternative Voltage, 230V / 50-60 Hz		CONFIG_F0_F1_230_VOLT			
Alternative Voltage, 380V / 60 Hz		CONFIG_F0-F4_380_VOLT			
Factory Fitted Filter Kit including By-Pass 7.5 kW		CONFIG_F1_FILT1			
Factory Fitted Filter Kit including By-Pass 11 kW		CONFIG_F1_FILT2			
Retro Filter Kit including By-Pass 7.5-11 kW for 270 Litre Receiver		CC1201969			
Retro Filter Kit including By-Pass 7.5-11 kW for 500 Litre Receiver		CC1201970			
Factory Fitted Automatic Drain		CONFIG_F0_F2_DRAIN			
AD2000 (internal separator vessel)		CONFIG_F0-F4_AD2000			
Factory Fitted Food Grade Oil		CONFIG_F1_FOODGRADE			
Extended 5 year warranty		CC1180791			
SERVICE & PARTS					
Service Kit for every 2000 h or 12 months		CC1221491			
Annual Kit FM07-11 VS		CC1180672			
Advanced Service Kit FM07-11 VS		CC1180678			
ChampLube Screw Lubricant 4 Ltr (x4)		CC1180019			
AEON SCFG 8000 5 Ltr		ZS1216903			
AEON SCFG 8000 20 Ltr		ZS1216945			
AEON SCFG 8000 208 Ltr		ZS1216946			

FM 11 RS Series: Screw Compressors

Design: Oil flooded, Single stage rotary screw compressor, variable speed, air cooled
Pressure Range: 5 to 13 bar
Electric motor: 11 kW - IE3



FM SERIES CODE	TYPE	FM11RS			
		CC1184160	CC1184161	CC1184162	CC1184163
Maximum pressure	bar	7	8	10	13
Capacity at maximum pressure and 100% load	m ³ /min	1.58	1.56	1.39	1.07
Drive motor IP 55 / class F – IE3	kW	11	11	11	11
Operating Voltage, 50Hz	400 V	•	•	•	•
Control voltage	24 V	•	•	•	•
C-Pro 2.0 electronic controller		•	•	•	•
Noise Level at 70% load	db(A)	67	67	67	67
After-cooler		•	•	•	•
Weight	kg	234	234	234	234
Dimensions (LxWxH)	mm	667x630x1050	667x630x1050	667x630x1050	667x630x1050
Outlet connection EN 10266 (DIN 2999)		3/4"	3/4"	3/4"	3/4"

COMPRESSOR MOUNTED ON 270 LT TANK					
Code		RSCCP1117	RSCCP1118	RSCCP1119	RSCCP1120
Weight	kg	329	329	329	329
Dimensions (LxWxH)	mm	1600x700x1600	1600x700x1600	1600x700x1600	1600x700x1600

COMPRESSOR MOUNTED ON 500 LT TANK					
Code		RSCCP1121	RSCCP1122	RSCCP1123	RSCCP1124
Weight	kg	394	394	394	394
Dimensions (LxWxH)	mm	2000x700x1700	2000x700x1700	2000x700x1700	2000x700x1700

PACKAGE VERSION, FM / CT / 270 ¹⁾					
Code		RSCCP1133V4	RSCCP1134V4	RSCCP1135V4	RSCCP1136V4
Weight	kg	369	369	369	369
Dimensions (LxWxH)	mm	1600x700x1600	1600x700x1600	1600x700x1600	1600x700x1600

PACKAGE VERSION, FM / CT / 500 ¹⁾					
Code		RSCCP1137V4	RSCCP1138V4	RSCCP1139V4	RSCCP1140V4
Weight	kg	434	434	434	434
Dimensions (LxWxH)	mm	2000x700x1700	2000x700x1700	2000x700x1700	2000x700x1700

OPTIONAL	
Alternative Voltage, 230V / 50-60 Hz (3 phases)	CONFIG_F0_F1_230_VOLT
Alternative Voltage, 380V / 60 Hz	CONFIG_F0-F4_380_VOLT
Factory Fitted Filter Kit including By-Pass 7.5 kW	CONFIG_F1_FILT1
Factory Fitted Filter Kit including By-Pass 11 kW	CONFIG_F1_FILT2
Retro Filter Kit including By-Pass 7.5-11 kW for 270 Litre Receiver	CC1201969
Retro Filter Kit including By-Pass 7.5-11 kW for 500 Litre Receiver	CC1201970
Factory Fitted Automatic Drain	CONFIG_F0_F2_DRAIN
AD2000 (internal separator vessel)	CONFIG_F0-F4_AD2000
Factory Fitted Food Grade Oil	CONFIG_F1_FOODGRADE
Extended 5 year warranty	CC1180791
SERVICE & PARTS	
Service Kit for every 2000 h or 12 months	CC1221491
Annual Kit FM07-11 VS	CC1180672
Advanced Service Kit FM07-11 VS	CC1180678
ChampLube Screw Lubricant 4 Ltr (x4)	CC1180019
AEON SCFG 8000 5 Ltr	ZS1216903
AEON SCFG 8000 20 Ltr	ZS1216945
AEON SCFG 8000 208 Ltr	ZS1216946

FM FIXED SPEED, FM RS VARIABLE SPEED

Elite 7 & 11 Series: Rotary Screw Compressors

Design: Rotary screw compressor mounted onto a horizontal tank, refrigerated dryer, filtration pack, automatic condensate drain and an oil/water separator.

Pressure Range: 10 bar

Electric motor: 7.5 - 11kW - IE3



ELITE SERIES CODE	TYPE	ELITE 7		ELITE 11	
		RSCCP0741V4		RSCCP1141V4	
Receiver	litres	270		270	
Drive Motor	kW	7.5		11	
Voltage	V	400/50		400/50	
Capacity at maximum pressure	m ³ /min	0.97		1.39	
Maximum Pressure	bar	10		10	
Noise Level	dB (A)	70		70	
Connection	inches	3/4"		3/4"	
Dimensions	mm	1539 x 1535 x 787		1539 x 1535 x 787	
Weight	kg	364		378	
OPTIONAL					
Alternative Voltage 230V/50-60 Hz		CONFIG_F0_F1_230_VOLT			
Alternative Voltage 380/3/60 Hz		CONFIG_F0-F4_380_VOLT			
AD2000 (internal separator vessel)		CONFIG_F0-F4_AD2000			
Factory Fitted Food Grade Oil		CONFIG_F1_FOODGRADE			
Extended 5 year warranty		CC1180791			

FM 15 Series: Screw Compressors

Design: Oil flooded, Single stage rotary screw compressor, belt drive, air cooled

Pressure Range: 7 to 13 bar

Electric motor: 15 kW - IE3



FM SERIES CODE	TYPE	FM15			
		CC1184171	CC1184172	CC1184173	CC1184264
Maximum pressure	bar	7	8	10	13
Capacity at maximum pressure	m ³ /min	2.64	2.46	2.20	1.79
Drive motor IP 55 / class F – IE3	kW	15	15	15	15
Operating Voltage, 50Hz	400 V	•	•	•	•
Control voltage	24 V	•	•	•	•
C-Pro 2.0 electronic controller		•	•	•	•
Noise Level	db(A)	73	73	73	73
After-cooler		•	•	•	•
Weight	kg	335	335	335	335
Dimensions (LxWxH)	mm	787x698x1202	787x698x1202	787x698x1202	787x698x1202
Outlet connection EN 10266 (DIN 2999)		1"	1"	1"	1"
COMPRESSOR MOUNTED ON 500 LT TANK					
Code		RSCCP1509	RSCCP1510	RSCCP1511	RSCCP1512
Weight	kg	495	495	495	495
Dimensions (LxWxH)	mm	2000x800x1850	2000x800x1850	2000x800x1850	2000x800x1850
PACKAGE VERSION, FM / CT / 500¹⁾					
Code		RSCCP1517V4	RSCCP1518V4	RSCCP1519V4	RSCCP1520V4
Weight	kg	545	545	545	545
Dimensions (LxWxH)	mm	2000x850x1850	2000x850x1850	2000x850x1850	2000x850x1850

FM 15 Series: Screw Compressors Continued

OPTIONAL	
Alternative Voltage 380/3/60 Hz	CONFIG_F0-F4_380_VOLT
Factory Fitted Filter Kit including By-Pass 15-22 kW	CONFIG_F2_FILT1
Retro Fit Filter Pack with By-Pass 15-22 kW	CC1199134
Factory Fitted Automatic Drain	CONFIG_F0_F2_DRAIN
Factory Fitted Food Grade Oil	CONFIG_F2_FOODGRADE
Extended 5 year warranty	CC1180791
SERVICE & PARTS	
Service Kit for every 2000 h or 12 months	CC1221492
Annual Kit FM15-22	CC1180685
Advanced Service Kit FM15-22	CC1180689
ChampLube Screw Lubricant 4 Ltr (x4)	CC1180019
AEON SCFG 8000 5 Ltr	ZS1216903
AEON SCFG 8000 20 Ltr	ZS1216945
AEON SCFG 8000 208 Ltr	ZS1216946

FM 18 Series: Screw Compressors

Design: Oil flooded, Single stage rotary screw compressor, belt drive, air cooled

Pressure Range: 7 to 13 bar

Electric motor: 18.5 kW - IE3



FM SERIES CODE	TYPE	FM18			
		CC1184265	CC1184266	CC1184267	CC1184268
Maximum pressure	bar	7	8	10	13
Capacity at maximum pressure	m ³ /min	3.15	2.96	2.71	2.38
Drive motor IP 55 / class F – IE3	kW	18.5	18.5	18.5	18.5
Operating Voltage, 50Hz	400 V	•	•	•	•
Control voltage	24 V	•	•	•	•
C-Pro 2.0 electronic controller		•	•	•	•
Noise Level	db(A)	73	73	73	73
After-cooler		•	•	•	•
Weight	kg	361	361	361	361
Dimensions (L x W x H)	mm	787x698x1202	787x698x1202	787x698x1202	787x698x1202
Outlet connection EN 10266 (DIN 2999)		1"	1"	1"	1"

COMPRESSOR MOUNTED ON 500 LT TANK					
Code		RSCCP1809	RSCCP1810	RSCCP1811	RSCCP1812
Weight	kg	521	521	521	521
Dimensions (L x W x H)	mm	2000x800x1850	2000x800x1850	2000x800x1850	2000x800x1850

PACKAGE VERSION, FM / CT / 500 ⁽¹⁾					
Code		RSCCP1817V4	RSCCP1818V4	RSCCP1819V4	RSCCP1820V4
Weight	kg	571	571	571	571
Dimensions (L x W x H)	mm	2000x850x1850	2000x850x1850	2000x850x1850	2000x850x1850

OPTIONAL	
Alternative Voltage 380/3/60 Hz	CONFIG_F0-F4_380_VOLT
Factory Fitted Filter Kit including By-Pass 15-22 kW	CONFIG_F2_FILT1
Retro Fit Filter Pack with By-Pass 15-22 kW	CC1199134
Factory Fitted Automatic Drain	CONFIG_F0_F2_DRAIN
Factory Fitted Food Grade Oil	CONFIG_F2_FOODGRADE
Extended 5 year warranty	CC1180791
SERVICE & PARTS	
Service Kit for every 2000 h or 12 months	CC1221492
Annual Kit FM15-22	CC1180685
Advanced Service Kit FM15-22	CC1180689
ChampLube Screw Lubricant 4 Ltr (x4)	CC1180019
AEON SCFG 8000 5 Ltr	ZS1216903
AEON SCFG 8000 20 Ltr	ZS1216945
AEON SCFG 8000 208 Ltr	ZS1216946

FM FIXED SPEED, FM RS VARIABLE SPEED



FM 22 Series: Screw Compressors

Design: Oil flooded, Single stage rotary screw compressor, belt drive, air cooled

Pressure Range: 7 to 13 bar

Electric motor: 22 kW - IE3

FM SERIES CODE	TYPE	FM22			
		CC1184269	CC1184270	CC1184169	CC1184271
Maximum pressure	bar	7	8	10	13
Capacity at maximum pressure	m ³ /min	3.50	3.23	3.06	2.59
Drive motor IP 55 / class F – IE3	kW	22	22	22	22
Operating Voltage, 50Hz	400 V	•	•	•	•
Control voltage	24 V	•	•	•	•
C-Pro 2.0 electronic controller		•	•	•	•
Noise Level	db(A)	74	74	74	74
After-cooler		•	•	•	•
Weight	kg	367	367	367	367
Dimensions (LxWxH)	mm	787x698x1202	787x698x1202	787x698x1202	787x698x1202
Outlet connection EN 10266 (DIN 2999)		1"	1"	1"	1"
COMPRESSOR MOUNTED ON 500 LT TANK					
Code		RSCCP2209	RSCCP2210	RSCCP2211	RSCCP2212
Weight	kg	527	527	527	527
Dimensions (LxWxH)	mm	2000x800x1850	2000x800x1850	2000x800x1850	2000x800x1850
PACKAGE VERSION, FM / CT / 500 ¹⁾					
Code		RSCCP2217V4	RSCCP2218V4	RSCCP2219V4	RSCCP2220V4
Weight	kg	577	577	577	577
Dimensions (LxWxH)	mm	2000x850x1850	2000x850x1850	2000x850x1850	2000x850x1850
OPTIONAL					
Alternative Voltage 380/3/60 Hz		CONFIG_F0-F4_380_VOLT			
Factory Fitted Filter Kit including By-Pass 15-22 kW		CONFIG_F2_FILT1			
Retro Fit Filter Pack with By-Pass 15-22 kW		CC1199134			
Factory Fitted Automatic Drain		CONFIG_F0_F2_DRAIN			
Factory Fitted Food Grade Oil		CONFIG_F2_FOODGRADE			
Extended 5 year warranty		CC1180791			
SERVICE & PARTS					
Service Kit for every 2000 h or 12 months		CC1221492			
Annual Kit FM15-22		CC1180685			
Advanced Service Kit FM15-22		CC1180689			
ChampLube Screw Lubricant 4 Ltr (x4)		CC1180019			
AEON SCFG 8000 5 Ltr		ZS1216903			
AEON SCFG 8000 20 Ltr		ZS1216945			
AEON SCFG 8000 208 Ltr		ZS1216946			

FM 15 RS Series: Screw Compressors

Design: Oil flooded, Single stage rotary screw compressor, variable speed, air cooled

Pressure Range: 5 to 13 bar

Electric motor: 15 kW - IE3



FM SERIES CODE	TYPE	FM15RS			
		CC1184272	CC1184273	CC1184274	CC1184275
Maximum pressure	bar	7	8	10	13
Capacity at maximum pressure and 100% load	m ³ /min	2.64	2.46	2.20	1.73
Drive motor IP 55 / class F – IE3	kW	15	15	15	15
Operating Voltage, 50Hz	400 V	•	•	•	•
Control voltage	24 V	•	•	•	•
C-Pro 2.0 electronic controller		•	•	•	•
Noise Level at 70% load	db(A)	70	70	70	70
After-cooler		•	•	•	•
Weight	kg	360	360	360	360
Dimensions (L x W x H)	mm	787x698x1202	787x698x1202	787x698x1202	787x698x1202
Outlet connection EN 10266 (DIN 2999)		1"	1"	1"	1"

COMPRESSOR MOUNTED ON 500 LT TANK					
Code		RSCCP1513	RSCCP1514	RSCCP1515	RSCCP1516
Weight	kg	520	520	520	520
Dimensions (L x W x H)	mm	2000x800x1850	2000x800x1850	2000x800x1850	2000x800x1850

PACKAGE VERSION, FM / CT / 500 ¹⁾					
Code		RSCCP1521V4	RSCCP1522V4	RSCCP1523V4	RSCCP1524V4
Weight	kg	570	570	570	570
Dimensions (L x W x H)	mm	2000x850x1850	2000x850x1850	2000x850x1850	2000x850x1850

OPTIONAL	
Alternative Voltage 380/3/60 Hz	CONFIG_F0-F4_380_VOLT
FM15-22 Filter Kit with bypass for dryer	CONFIG_F2_FILT1
Retro Fit Filter Pack with By-Pass 15-22 kW	CC1199134
Factory Fitted Automatic Drain	CONFIG_F0_F2_DRAIN
Factory Fitted Food Grade Oil	CONFIG_F2_FOODGRADE
Extended 5 year warranty	CC1180791
SERVICE & PARTS	
Service Kit for every 2000 h or 12 months	CC1221492
Annual Kit FM15-22 VS	CC1180686
Advanced Service Kit FM15-22 VS	CC1180690
ChampLube Screw Lubricant 4 Ltr (x4)	CC1180019
AEON SCFG 8000 5 Ltr	ZS1216903
AEON SCFG 8000 20 Ltr	ZS1216945
AEON SCFG 8000 208 Ltr	ZS1216946

FM FIXED SPEED, FM RS VARIABLE SPEED

FM 18 RS Series: Screw Compressors

Design: Oil flooded, Single stage rotary screw compressor, variable speed, air cooled

Pressure Range: 5 to 13 bar

Electric motor: 18.5 kW - IE3



FM SERIES CODE	TYPE	FM18RS			
		CC1184277	CC1184278	CC1184279	CC1184280
Maximum pressure	bar	7	8	10	13
Capacity at maximum pressure	m ³ /min	3.15	2.96	2.66	2.25
Drive motor IP 55 / class F – IE3	kW	18.5	18.5	18.5	18.5
Operating Voltage, 50Hz	400 V	•	•	•	•
Control voltage	24 V	•	•	•	•
C-Pro 2.0 electronic controller		•	•	•	•
Noise Level	db(A)	71	71	71	71
After-cooler		•	•	•	•
Weight	kg	380	380	380	380
Dimensions (L x W x H)	mm	787x698x1202	787x698x1202	787x698x1202	787x698x1202
Outlet connection EN 10266 (DIN 2999)		1"	1"	1"	1"
COMPRESSOR MOUNTED ON 500 LT TANK					
Code		RSCCP1813	RSCCP1814	RSCCP1815	RSCCP1816
Weight	kg	540	540	540	540
Dimensions (L x W x H)	mm	2000x800x1850	2000x800x1850	2000x800x1850	2000x800x1850
PACKAGE VERSION, FM / CT / 500 ¹⁾					
Code		RSCCP1821V4	RSCCP1822V4	RSCCP1823V4	RSCCP1824V4
Weight	kg	590	590	590	590
Dimensions (L x W x H)	mm	2000x850x1850	2000x850x1850	2000x850x1850	2000x850x1850
OPTIONAL					
Alternative Voltage 380/3/60 Hz		CONFIG_F0-F4_380_VOLT			
FM15-22 Filter Kit with bypass for dryer		CONFIG_F2_FILT1			
Retro Fit Filter Pack with By-Pass 15-22 kW		CC1199134			
Factory Fitted Automatic Drain		CONFIG_F0_F2_DRAIN			
Factory Fitted Food Grade Oil		CONFIG_F2_FOODGRADE			
Extended 5 year warranty		CC1180791			
SERVICE & PARTS					
Service Kit for every 2000 h or 12 months		CC1221492			
Annual Kit FM15-22 VS		CC1180686			
Advanced Service Kit FM15-22 VS		CC1180690			
ChampLube Screw Lubricant 4 Ltr (x4)		CC1180019			
AEON SCFG 8000 5 Ltr		ZS1216903			
AEON SCFG 8000 20 Ltr		ZS1216945			
AEON SCFG 8000 208 Ltr		ZS1216946			

FM 22 RS Series: Screw Compressors

Design: Oil flooded, Single stage rotary screw compressor, variable speed, air cooled

Pressure Range: 5 to 13 bar

Electric motor: 22 kW - IE3



FM SERIES CODE	TYPE	FM22RS			
		CC1184281	CC1184282	CC1183666	CC1184283
Maximum pressure	bar	7	8	10	13
Capacity at maximum pressure and 100% load	m ³ /min	3.50	3.23	3.06	2.59
Drive motor IP 55 / class F – IE3	kW	22	22	22	22
Operating Voltage, 50Hz	400 V	•	•	•	•
Control voltage	24 V	•	•	•	•
C-Pro 2.0 electronic controller		•	•	•	•
Noise Level at 70% load	db(A)	71	71	71	71
After-cooler		•	•	•	•
Weight	kg	395	395	395	395
Dimensions (L x W x H)	mm	787x698x1202	787x698x1202	787x698x1202	787x698x1202
Outlet connection EN 10266 (DIN 2999)		1"	1"	1"	1"

COMPRESSOR MOUNTED ON 500 LT TANK					
Code		RSCCP2213	RSCCP2214	RSCCP2215	RSCCP2216
Weight	kg	555	555	555	555
Dimensions (L x W x H)	mm	2000x800x1850	2000x800x1850	2000x800x1850	2000x800x1850

PACKAGE VERSION, FM / CT / 500 ¹⁾					
Code		RSCCP2221V4	RSCCP2222V4	RSCCP2223V4	RSCCP2224V4
Weight	kg	605	605	605	605
Dimensions (L x W x H)	mm	2000x850x1850	2000x850x1850	2000x850x1850	2000x850x1850

OPTIONAL	
Alternative Voltage 380/3/60 Hz	CONFIG_F0-F4_380_VOLT
FM15-22 Filter Kit with bypass for dryer	CONFIG_F2_FILT1
Retro Fit Filter Pack with By-Pass 15-22 kW	CC1199134
Factory Fitted Automatic Drain	CONFIG_F0_F2_DRAIN
Factory Fitted Food Grade Oil	CONFIG_F2_FOODGRADE
Extended 5 year warranty	CC1180791
SERVICE & PARTS	
Service Kit for every 2000 h or 12 months	CC1221492
Annual Kit FM15-22 VS	CC1180686
Advanced Service Kit FM15-22 VS	CC1180690
ChampLube Screw Lubricant 4 Ltr (x4)	CC1180019
AEON SCFG 8000 5 Ltr	ZS1216903
AEON SCFG 8000 20 Ltr	ZS1216945
AEON SCFG 8000 208 Ltr	ZS1216946

NEW GENERATION HIGHLY EFFICIENT SCREW COMPRESSORS

At a glance...

 **Nominal Pressure**
5 - 13 bar g

 **Motor Power**
30 - 75kW

 **Volume Flow**
1.19 - 13.5 m³/min



Premium efficiency airend

New FM series 30-75 kW features premium quality airends designed and manufactured in house. The manufacturing process is using the latest CNC rotor grinding machinery, coupled with on-line laser technology, in order to maintain precise manufacturing tolerances.

Our state of art airends are focused on high efficiency and reliability.

Their integrated design offers a very compact solution that ease service and minimises leakage risks.

High efficiency cooling system

Thanks to the optimum cooling system, the compressor can work in high ambient temperatures of up to 46°C.

Maximum durability

We maximise service life and durability by eliminating elastomer and thermoplastic pipe and tube in system pressure lines, replacing them with corrosion resistant stainless steel tubing and passive zinc coated carbon steel piping.

Semi Integrated Version

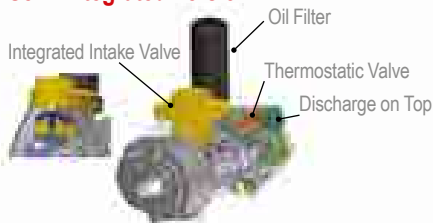

For ease of maintenance we complete the connection with viton sealed, grooved couplings and self-sealing high pressure compression fittings.

Designed for serviceability

Maintenance personnel welcome the FM series compressor range. Service access is quick and easy with all doors able to be removed in seconds. We've also made sure serviceable components including filters are easily accessible and no piping needs to be disconnected to service the separator.



Optimised drive concept

With direct or gear drive coupling, the belt free FM 30-75 Series compressor range not only reduces transmission losses, it improves efficiency and reduces noise. Most importantly, it delivers greater reliability and reduced maintenance costs.

Energy efficient motor

High efficiency TEFC IE3 electric motors are fitted as standard to the entire FM 30-75 Series screw compressor range, reducing not only power consumption but also CO₂ emissions.



New advanced controller C-PRO 2.0 ensures reliable operation and protects your investment by continuously monitoring the operational parameters

- ✓ 3 analog inputs
- ✓ Multi-language: English/German/French/Italian/Spanish
- ✓ Standard sequence control up to 8 units (up to 7 units fixed speed & 1 variable speed)
- ✓ Standard Modbus
- ✓ 15 failure records in memory
- ✓ Continuous system monitoring



iConn Industry 4.0 option

The C- PRO 2.0 has the possibility to connect with iConn monitoring device iConn is the smart, proactive real-time monitoring service that delivers in-depth and real-time knowledge on the system to our compressed air users. It enables accurate production planning and total peace-of-mind protection.

It keeps users informed on performance, at the same time highlighting potential issues before they become a problem.

- Condition based monitoring
- Predictive maintenance required
- Full Air Manufacturing Control Optimisation
- External data pattern integration

FM FIXED SPEED - FMRS VARIABLE SPEED SERIES

FM RS



= Energy savings and lower CO₂ emissions into the environment.

The variable speed compressor: One smart solution

Variable speed compressors can efficiently and reliably handle the varying air demand found in most plant air systems. These compressors speed up and slow down to match air supply to air demand as it fluctuates. The right variable speed compressor in the right application delivers significant energy savings and a stable, consistent air supply.

Compressor energy cost example

NOMINAL kW	OPERATING COST PER YEAR (5000 HOURS) AT COST PER kWh (€)					
	0.06	0.08	0.10	0.12	0.14	0.16
55	16,500	22,000	27,500	33,000	38,500	44,000
75	22,500	30,000	37,500	45,000	52,500	60,000

Note: Hours of operation based on two 8hrs-shifts, 6 days per week. Calculations based on nominal kW.



Cost of compressed air over 5 years

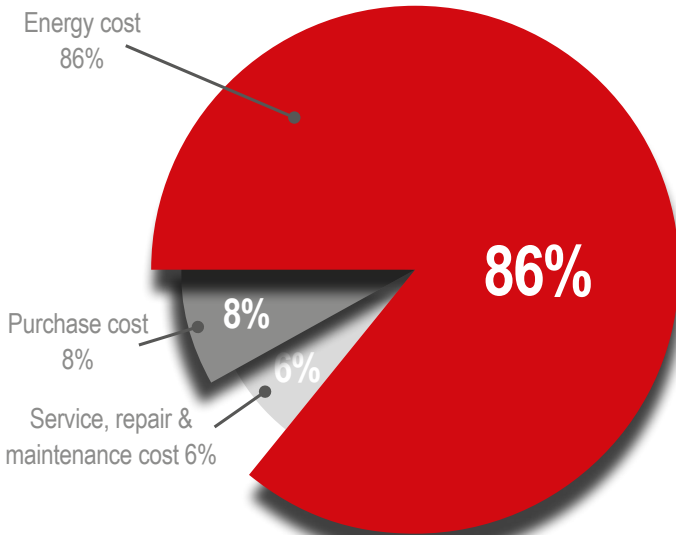

FM-RS Series features Power Drive Systems that exceed the class IES2 EN61800-9 requirements and assure high efficiency and high energy savings levels.



Allows substantial energy savings of at least 25% of the energy cost

The intelligent C-PRO 2.0 controller

Simplicity

The C-PRO 2.0 controller was designed to make the operators' interface with the variable speed drive transparent. This new generation controller features extra functions for variable speed compressors like drive status display and flexible PID setting according to the application. You don't need to be an expert on variable speed drives to operate your compressor. The controller takes care of the details and automatically adjusts the compressor performance to meet your changing air system demands - saving you energy. Changing the discharge pressure is as easy as pressing a button.



Technical data

FM 30 – 45 Series: Screw Compressors, Fixed Speed

Design: Oil flooded, Single stage rotary screw compressor, direct drive, star / delta starting

Pressure Range: 8 to 13 bar

Electric motor: 30 - 45kW - IE3



FM SERIES CODE	TYPE	FM 30			FM 37			FM 45		
		CC1195721	CC1195722	CC1195723	CC1195342	CC1195734	CC1195735	CC1195736	CC1195737	CC1195738
Max. Pressure	bar	8	10	13	8	10	13	8	10	13
Capacity at working pressure	m ³ /min	4.87	4.67	4.08	6.4	5.49	5.05	7.52	6.75	5.4
Drive Motor IP55 / Class IE3	kW	30	30	30	37	37	37	45	45	45
Operating Voltage, 50 Hz	400 V	•	•	•	•	•	•	•	•	•
Control Voltage	24V	•	•	•	•	•	•	•	•	•
C-PRO 2.0 Controller		•	•	•	•	•	•	•	•	•
Noise Level	dB(A)	71	71	71	71	71	71	72	72	72
Weight	kg	700			780			850		
Dimensions (LxWxH)	mm	1554 x 894 x 1405			1554 x 894 x 1405			1554 x 894 x 1405		
Compressed Air Delivery Connection		EN 10226 G1 1/4 (DIN 2999-G1 1/4) female								

OPTIONAL	
Alternative Voltage 380/3/60Hz	CONFIG_F0-F4_380_VOLT
iConn Factory Fitted	CONFIG_iConn
iConn Retrofit Kit	ZS1216381
NETT PRICE	
Extended Warranty 5 years	CC1180793
AD2000 (internal separator vessel)	CONFIG_F0-F4_AD2000
Factory Fitted Food Grade Oil 30-45 kW	CONFIG_F3_FOODGRADE
FM/FMRS 30-45 HRC - Factory Fitted **	CONFIG_HRC_F3
SERVICE & PARTS	
Annual Service Kit FM30	CC1198084
Advanced Service Kit FM30	CC1198090
Major Service Kit FM30	CC1198096
Annual Service Kit FM37-45	CC1198085
Advanced Service Kit FM37-45	CC1198091
Major Service Kit FM37-FM45	CC1198097
ChampLube Screw Lubricant 20 Ltr	CC1180020
AEON SCFG 8000 5 Ltr	ZS1216903
AEON SCFG 8000 20 Ltr	ZS1216945
AEON SCFG 8000 208 Ltr	ZS1216946

* Service intervals are by calendar months or operating hours, whichever occurs first. In dirty ambient conditions service interval must be halved.

** Please note that this is the internal connection kit which enables to connect the compressor to the External CH-Airwatt Heat Recovery units on page 116 of this Price Book.

FM FIXED SPEED - FMRS VARIABLE SPEED SERIES

FM 30 – 45RS Series: Screw Compressors, Variable Speed

Design: Oil flooded, single stage rotary screw compressor, direct drive, star / delta starting

Pressure Range: 5 to 13 bar

Electric motor: 30 - 45kW - IE3



FMRS SERIES CODE	TYPE	FM30RS CC1195739	FM37RS CC1195740	FM45RS CC1195741
Pressure Range	bar	5 - 13		
Flow rate min - max	m ³ /min	1.19 - 5.60	1.41 - 6.69	1.41 - 7.84
Drive Motor IP55 / Class IE3	kW	30	37	45
Operating Voltage, 50 Hz	400V	•	•	•
Control Voltage	24V	•	•	•
C- PRO 2.0 Controller		•	•	•
Noise Level at 70% load	dB(A)	70	70	71
Weight	kg	750	830	900
Dimensions (LxWxH)	mm	1554 x 894 x 1405		
Compressed Air Delivery Connection		EN 10226 G1 1/4 (DIN 2999-G1 1/4) female		

OPTIONAL	
Alternative Voltage 380/3/60Hz	CONFIG_F0-F4_380_VOLT
iConn Factory Fitted	CONFIG_iConn
iConn Retrofit Kit NETT PRICE	ZS1216381
Extended Warranty 5 years	CC1180793
AD2000 (internal separator vessel)	CONFIG_F0-F4_AD2000
Factory Fitted Food Grade Oil 30-45 kW	CONFIG_F3_FOODGRADE
FM/FMRS 30-45 HRC - Factory Fitted **	CONFIG_HRC_F3
SERVICE & PARTS	
Annual Service Kit FMRS30	CC1198086
Advanced Service Kit FMRS30	CC1198092
Major Service Kit FM30 RS	CC1198098
Annual Service Kit FMRS37-45	CC1198087
Advanced Service Kit FMRS37-45	CC1198093
Major Service Kit FMRS37- FMRS45	CC1198099
ChampLube Screw Lubricant 20 Ltr (x2)	CC1180020
AEON SCFG 8000 5 Ltr	ZS1216903
AEON SCFG 8000 20 Ltr	ZS1216945
AEON SCFG 8000 208 Ltr	ZS1216946

* Service intervals are defined by calendar months or operating hours, whichever occurs first. In dirty ambient conditions service interval must be halved.

** Please note that this is the internal connection kit which enables to connect the compressor to the External CH-Airwatt Heat Recovery units on page 116 of this Price Book.

FM 55 – 75 Series: Screw Compressors, Fixed Speed

Design: Oil flooded, single stage rotary screw compressor, direct drive, star / delta starting

Pressure Range: 8 to 13 bar

Electric motor: 55 - 75kW - IE3



FM SERIES CODE	TYPE	FM55			FM75		
		CC1195745	CC1195747	CC1195748	CC1195749	CC1195750	CC1195751
Pressure Range	bar	8	10	13	8	10	13
Capacity at working pressure	m ³ /min	10.55	9.14	7.9	12.15	10.26	8.91
Drive Motor IP55 / Class IE3	kW	55	55	55	75	75	75
Operating Voltage, 50 Hz	400V	•	•	•	•	•	•
Control Voltage	24V	•	•	•	•	•	•
C- PRO 2.0 Controller		•	•	•	•	•	•
Noise Level at 70% load	dB(A)	73	73	73	74	74	74
Weight	kg	1150			1210		
Dimensions (LxWxH)	mm	2004 x 1179 x 1505			2004 x 1179 x 1505		
Compressed Air Delivery Connection		EN 10226 G2 (DIN 2999-G2) female					

OPTIONAL	
Alternative Voltage 380/3/60Hz	CONFIG_F0-F4_380_VOLT
iConn Factory Fitted	CONFIG_iConn
iConn Retrofit Kit NETT PRICE	ZS1216381
Extended Warranty 5 years	CC1180793
AD2000 (internal separator vessel)	CONFIG_F0-F4_AD2000
Factory Fitted Food Grade Oil 55-75 kW	CONFIG_F4_FOODGRADE
FM/FMRS 55-75 HRC - Factory Fitted **	CONFIG_HRC_F4
SERVICE & PARTS	
Annual Service Kit FM55-75	CC1198088
Advanced Service Kit FM55-75	CC1198094
Major Service Kit FM55	CC1198100
Major Service Kit FM75	CC1198101
AEON SCFG 8000 5 Ltr	ZS1216903
AEON SCFG 8000 20 Ltr	ZS1216945
AEON SCFG 8000 208 Ltr	ZS1216946

* Service intervals are defined by calendar months or operating hours, whichever occurs first. In dirty ambient conditions service interval must be halved.

** Please note that this is the internal connection kit which enables to connect the compressor to the External CH-Airwatt Heat Recovery units on page 116 of this Price Book.

FM FIXED SPEED - FMRS VARIABLE SPEED SERIES

FM 55 – 75RS Series: Screw Compressors, Fixed Speed

Design: Oil flooded, single stage rotary screw compressor, direct drive, star / delta starting

Pressure Range: 5 to 13 bar

Electric motor: 55 - 75kW - IE3

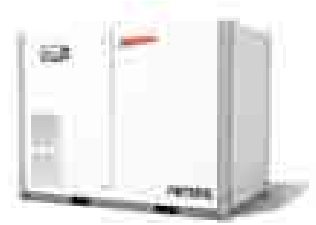

FM SERIES CODE	TYPE	FM55RS CC1195752	FM75RS CC1195753
Pressure Range	bar	5 - 10	5 - 13
Flow rate min - max	m ³ /min	2.24 - 10.43	1.65 - 13.57
Drive Motor IP55 / Class IE3	kW	55	75
Operating Voltage, 50 Hz	400V	•	•
Control Voltage	24V	•	•
C- PRO 2.0 Controller		•	•
Noise Level at 70% load	dB(A)	71	74
Weight	kg	1220	1280
Dimensions (LxWxH)	mm	2004 x 1179 x 1505	
Compressed Air Delivery Connection		EN 10226 G2 (DIN 2999-G2) female	

OPTIONAL	
Alternative Voltage 380/3/60Hz	CONFIG_F0-F4_380_VOLT
iConn Factory Fitted	CONFIG_iConn
iConn Retrofit Kit NETT PRICE	ZS1216381
Extended Warranty 5 years	CC1180793
AD2000 (internal separator vessel)	CONFIG_F0-F4_AD2000
Factory Fitted Food Grade Oil 55-75 kW	CONFIG_F4_FOODGRADE
FM/FMRS 55-75 HRC - Factory Fitted **	CONFIG_HRC_F4
SERVICE & PARTS	
Standard Service Kit FMRS55-75	CC1198089
Advanced Service Kit FMRS55-75	CC1198095
Major Service Kit FM55-FM75 RS	CC1198102
ChampLube Screw Lubricant 20 Ltr (x2) (55-90Kw)	CC1180020
AEON SCFG 8000 5 Ltr	ZS1216903
AEON SCFG 8000 20 Ltr	ZS1216945
AEON SCFG 8000 208 Ltr	ZS1216946

* Service intervals are defined by calendar months or operating hours, whichever occurs first. In dirty ambient conditions service interval must be halved.

** Please note that this is the internal connection kit which enables to connect the compressor to the External CH-Airwatt Heat Recovery units on page 116 of this Price Book.

BIG ON EFFICIENCY! CHAMPION ON PRICE!

At a glance...



Nominal Pressure
5 - 13 bar g



Motor Power
90 - 132kW



Volume Flow
5.26 - 24.79 m³/min



Premium efficiency airend

The new highly efficient airend delivers the highest quality compressed air at a low rotational speed, to help minimise the unit's energy consumption and achieve excellent performance.



Eliminating all Risks

Protect your investment and minimise downtimes with the 5-year extended warranty and with the Industry 4.0 Solution iConn.

Compressor Controller Pilot TS Features & functions

- Home Page – instant overview of the compressor status
- Real Time Clock – allows pre-setting of compressor starting/stopping
- Second Pressure Setting
- Integrated Cooling and Dryer Control
- Fault History Log – for in-depth analysis
- Remote Control via Programmable Inputs
- Auto Restart after Power Failure
- Optional Base Load Sequencing
- SD Card – stores several run characteristics



OUTSTANDING EFFICIENCY



FM RS Variable Speed Technology

Allows substantial energy savings of at least 25% of the energy cost

iConn Industry 4.0 Option

The controller Pilot TS has the possibility to connect with iConn monitoring device.

iConn is the smart, proactive real-time monitoring service that delivers in-depth and real-time knowledge on the system to our compressed air users. It enables accurate production planning and total peace-of-mind protection. iConn keeps users informed on performance, at the same time highlighting potential issues before they become a problem.

- Condition based monitoring
- Predictive maintenance required
- Full Air Manufacturing Control Optimisation
- External data pattern integration

effiDRIVE

FM-RS Series features Power Drive Systems that exceed the class IES2 EN61800-9 requirements and assure high efficiency and high energy savings levels.

iConn

FM FIXED SPEED - FMRS VARIABLE SPEED SERIES

Technical data

FM 90 – 132 Series Screw Compressors, Fixed Speed

Design: Oil flooded, Single stage rotary screw compressor, direct drive, star / delta starting

Pressure Range: 7.5 to 13 bar

Electric motor: 90 - 132kW - IE3



FM SERIES CODE	TYPE	FM90			FM110			FM132		
		A34905437	A34905438	Configurator FM9013	A34905440	A34905441	Configurator FM11013	A34905443	A34905444	Configurator FM13213
	REC	FLOOR	FLOOR	FLOOR	FLOOR	FLOOR	FLOOR	FLOOR	FLOOR	FLOOR
Max. Pressure	bar	7.5	10	13	7.5	10	13	7.5	10	13
	PSI	109	145	188	109	145	188	109	145	188
	CFM	641.32	547.74	477.46	762.80	665.69	581.64	875.46	759.63	660.39
Capacity at working pressure	m ³ /min	18.16	15.51	13.52	21.60	18.85	16.47	24.79	21.51	18.70
Drive Motor IP55 / Class IE3	kW	90	90	90	110	110	110	132	132	132
	HP	125	125	125	150	150	150	180	180	180
Operating Voltage, 50 Hz	400 V	•	•	•	•	•	•	•	•	•
Air Cooled		•	•	•	•	•	•	•	•	•
Noise Level	dB(A)	75	75	75	77	77	77	78	78	78
Weight	kg	2447			2532			2764		
Dimensions (LxWxH)	mm	2290 x 1327 x 2039			2290 x 1327 x 2039			2290 x 1327 x 2039		
Compressed Air Delivery Connection		EN 10226 R 2 1/2								

OPTIONAL

Alternative Voltage 380V/60Hz

Heat Recovery Integrated

Heat Recovery External

Heat Recovery Retro-fit Integrated

Heat Recovery Retro-fit External

Canopy Heater

Oil Thermostat 70°C

Food Grade Lubricant

Synthetic Oil

Water Separator + Drain

iConn Factory Fitted

iConn Retrofit kit NETT PRICE

Remote on-off

Filter Monitoring

Base Load Sequencing

Profibus

Potential free contact kit

Extended Warranty 5 years

SERVICE & PARTS

Service Kit for 4000h

Service Kit for 8000h

For 8000 Hrs Service both 4000 and 8000 Hrs kits must be purchased together

FM 90 – 132 RS Series Screw Compressors, Variable Speed

Design: Oil flooded, Single stage rotary screw compressor, direct drive, star / delta starting

Pressure Range: 5 to 13 bar

Electric motor: 90 - 132kW - IE3



FM SERIES CODE	TYPE	FM90RS A34905439	FM110RS A34905442	FM132RS A34905445
	REC	FLOOR	FLOOR	FLOOR
Max. Pressure	bar	5 - 13	5 - 13	5 - 13
	PSI	73 - 188	73 - 188	73 - 188
	CFM	185.76 - 641.32	186.76 - 759.63	187.76 - 874.40
Capacity at working pressure	m ³ /min	5.26 - 18.16	5.26 - 21.51	5.26 - 24.76
Drive Motor IP55 / Class IE3	kW	90	110	132
	HP	125	150	180
Operating Voltage, 50 Hz	400 V	•	•	•
Air Cooled		•	•	•
Noise Level	dB(A)	74	75	76
Weight	kg	2579	2604	2655
Dimensions (LxWxH)	mm	2290 x 1327 x 2039		
Compressed Air Delivery Connection		EN 10226 R 2 1/2		

OPTIONAL	
Alternative Voltage 380V/60Hz	CONFIG_VOLTAGE FM
Heat Recovery Integrated	CONFIG_HEAT_REC_INT FM
Heat Recovery External	CONFIG_HEAT_REC_EXT FM
Heat Recovery Retro-fit Integrated	ZS1196556
Heat Recovery Retro-fit External	ZS1196954
Canopy Heater	CONFIG_HEATER
Food Grade Lubricant	CONFIG_FOOD_GRADE_OIL FM
Synthetic Oil	CONFIG_SYNTHETIC_OIL FM
Water Separator + Drain	CONFIG_SEPARATOR FM
iConn Factory Fitted	CONFIG_iConn
iConn Retrofit kit NETT PRICE	ZS1216381
Remote on-off	CONFIG_REMOTE
Filter Monitoring	CONFIG_FILT_MON
Base Load Sequencing	CONFIG_BASE_LOAD
Profibus	CONFIG_PROF
Potential free contact kit	CONFIG_CONTACT_KIT
Extended Warranty 5 years	CC1180793
SERVICE & PARTS	
Service Kit for 4000h	SKFM90132-1-RS
Service Kit for 8000h	MKFM90132

For 8000 Hrs Service both 4000 and 8000 Hrs kits must be purchased together

SEQUENCE MULTIPLE COMPRESSORS

- C-PRO 1+
- C-PRO 2
- PILOT TS



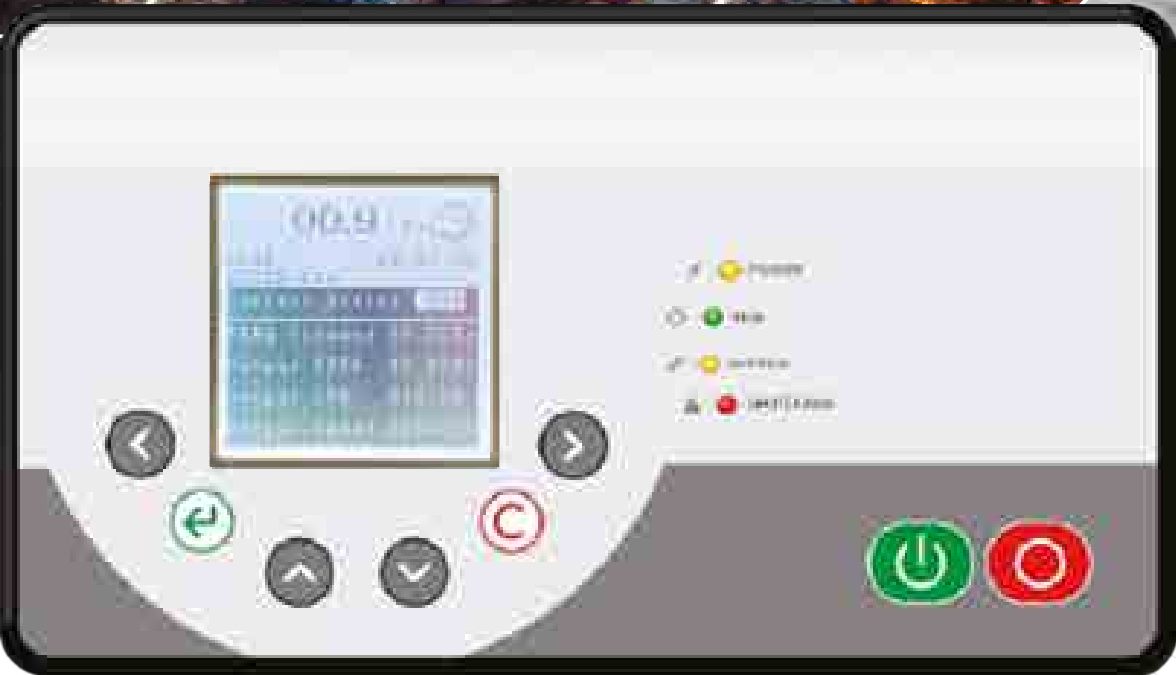

SEQUENCE MULTIPLE COMPRESSORS



SEQUENCE MULTIPLE COMPRESSORS

All the Champion controllers offer extra communication modules that allow several units to talk to each other and optimise system efficiency. Our controllers allow the system to truly optimise efficiency as they recognise the capabilities of other machines and their operation.

Depending on the controller and the type of the machine there are the following options :

UNITS TO SEQUENCE	QTY	FIXED SPEED ONLY				VARIABLE SPEED ONLY
		1-2	1-3	1-4	1-12	
Fixed Speed with C- Pro 1.0+ controller	ID number	211759A	CC1094891	ZS1071505	ZS1060135	—
	Module	2U	3U	Connect 4	Connect 12	—
Variable and fixed speed compressors in a unique system with C-Pro 1.0, and/or C-Pro 2.0 and/or Pilot TS*	UNITS / QTY	1-12 FIXED & VARIABLE SPEED				
	ID number	ZS1060135				
	Module	Connect 12				
Fixed speed compressors in a unique system with C-PRO 2.0 - FM series	UNITS / QTY	SEQUENCE 1-8 FIXED SPEED COMPRESSORS OR 1-7 FIXED SPEED & 1 VARIABLE SPEED				
	ID number	Standard module - included in C-PRO 2.0				
	Module	—				

*Additional module needed when C-Pro 2.0 is being connected with Connect 12

PROFESSIONAL AIR AUDITS



**Advanced Compressed Air
Energy Analyser**

Get the best out of your
compressed air system
and **reduce your
environmental impact**

With increasing energy costs a fact of life for business, and carbon and emissions levies and taxes a looming reality, the performance and efficiency of your compressed air systems have never been more important. Potential energy savings not only reduce the environmental impact of your business, they also return money to your bottom line.

Champion Air Audit - ultimately saving money and energy resources

Champion Audits provide complete air auditing services for compressed air systems:

- To achieve the lowest operating cost for the compressed air system and a fast return on any investment
- To improve manufacturing productivity

Accurate analysis AND solutions...

Champion Air Audits are performed to the highest standard!

- Delivering detailed reports and analysis of your compressed air system
- Identifying improvements in your compressed air system through system performance optimisation, leak reduction and practical air management processes



- ▼ Lower capital spending
- ▼ Lower your carbon footprint
- ▼ Save money and energy

Where are the savings made?

SUPPLY SIDE

10 to 20 % of the savings can be commonly found on the supply side of a compressed air system by identifying areas of identifying areas in:

Equipment

Technology

Controls

Monitoring

Equipment maintenance

Installation issues

DEMAND SIDE

A further 20 to 30% of savings can be commonly found on the demand side of a compressed air system by identifying areas of improvement in:

Compressed air leaks

Artificial demand

System dynamics

System design

Monitoring



Delivering tangible efficiencies through innovative energy consumption monitoring

Champion's latest cloud-based software data logging solution

- Combining unique application expertise with proven hardware and software platforms to deliver the complete, value-adding analytics service

Champion airINSITE has the facility to measure:

- Amps • Volts • kW • Pressure • Pressure Dewpoint
- Temperature • Any 4-20 ma signal • Actual flow

Our airINSITE data loggers incorporate high quality sensors to collect and store information relating to a system's pressure, temperature, pressure dew point and flow rate. Our current and voltage loggers enable true power to be accurately measured, with power costs calculated using these figures. The latest software technology allows us to analyse, chart, graph and prepare professional audit reports. Simulation wizards allow us to show you cost savings by simulating the use of different compressor configurations, of both fixed and variable, against your existing compressor volume.

Making **cost savings** has never been so easy

Champion airINSITE: Unique Compressed Air Energy Auditing system

Design: Compressed air energy analyser
Champions latest cloud-based software data logging solution

AIRINSITE COMPLETE CASE KITS		
MODEL	DESCRIPTION	MATERIAL NO.
airINSITE	Base station & PSU	ZS1088920
	Logger, 4–20mA – complete case kit	ZS1088921
	Logger, moisture (dew point) – complete case kit	ZS1088922
	Logger, flow – complete case kit	ZS1088923
	Logger, temperature (PT1000) – complete case kit	ZS1088924
	Logger, pressure (0 –16BAR) – complete case kit	ZS1088925
	Logger, current & volts – complete case kit	ZS1088926
	Accessory, logger carry case	ZS1106999
	Logger, 0–60 bar – complete case kit	ZS1133091
	Small logger, current & volts – complete case kit	ZS1160311

LEAKAGES				
MODEL	LEAK SIZE [MM]	LEAK VOLUME @7.5 BAR L/MIN	ENERGY LOSS [kW]	ENERGY LOSS [EUR/YEAR]
Leakage 1	1	75	0.6	315.00
Leakage 2	1.5	150	1.3	683.00
Leakage 3	2	260	2	1,051.00
Leakage 4	3	600	4.4	2,312.00
Leakage 5	4	1100	8.8	4,625.00
Leakage 6	5	1700	13.2	6,938.00

BASE, LINE, PRO & ADVANCED SERIES

PISTON COMPRESSORS

1.5 - 15 kW

- Coaxial version, single phase
- Belt driven, with canopy version
- Belt driven, three phase
- Pressure range 8 - 15 bar
- Electric motor 1.5 kW - 15 kW
- Voltage 230V & 400V



RELIABLE, STRONG SUITABLE FOR PROFESSIONAL USES

At a glance...



Nominal Pressure
8 - 15 bar g



Motor Power
1.5 - 15 kW



Volume Flow
190 - 3030 l/min
6.7 - 106.4 cfm



Power Sound level
68 - 82 dB(A)

Our company has always been associated with long-lasting high-quality products.

This range of piston compressors includes:

- Single-cylinder single-stage with direct transmission for small power outputs suitable for semi-professional uses
- Two-cylinder, single-stage with belt transmission for use in workshops
- Two-cylinder, two-stage with belt transmission for industrial use

Choosing the two-stage model will guarantee lower working temperatures thanks to a cooling manifold between the first and the second compression stage and consequently a higher air delivery. This is achieved by dividing the compression phase into two stages (two cylinders with different volumes).

Other important characteristics that distinguish this range of compressors are:

- Low number of RPM of the pumping unit
- Low noise level
- Correct ratio between the size of the unit, motor power and tank capacity



Base Series

This range of lubricated direct drive compressors are ideal for hobby and semi-professional applications. Choose from a power range of 1.5 to 3 HP with receiver capacities ranging from 3 to 100 litres and working pressures up to 9 Bar.

Line Series

This range of belt driven lubricated compressors for semi-professional, professional and light industrial use. The series is entirely manufactured in the EU and is available in power range 2 to 20 HP with tank capacity ranging from 25 to 900 litres and pressures up to 11 Bar.





Pro Series

This range is a comprehensive range of belt driven lubricated compressors for professional and industrial use. The series is manufactured in the EU and is defined by superior longevity and high construction quality. Available in power range of 2 to 30 HP with tank capacity ranging from 25 to 900 litres and pressures up to 11 Bar.



Advanced Series

This range offers the best in class option to satisfy the demand of professional and industrial applications. The series represents the best in range and stands out in terms of strong assembly, innovative technical solutions and excellence in detail and design. Power range from 2 to 30 HP with tank capacity ranging from 22 to 900 litres and pressures up to 15 Bar.



Engine Series

A comprehensive range of Honda petrol engine driven lubricated compressors incorporating the cast iron pump unit. Made in the EU with power ranges from 4 to 9 HP and tank capacities of 22 to 270 litres and pressures up to 10 Bar.



Silenced Series

This series of silenced belt driven lubricated compressors are designed to meet the needs of professional and industrial applications where low noise levels are critical. Available in a power range of 5.5 to 15 HP and working pressures up to 11 Bar with or without a refrigerated dryer



Choose the RIGHT solution

Direct Drive Aluminium Pump



- Simple utilisation
- Oil flutter lubrication
- Cast iron cylinders
- Aluminium piston with 3 rings
- Special inox steel valves
- High efficient ventilation

Belt Driven Cast Aluminium Pump



- Superior volumetric efficiency
- Aluminium finned cylinders with cast iron liners
- Fast dissipation of heat through the use after coolers
- High air flow flywheels
- Oil sight glass

Belt Driven Cast Iron Cylinder Pump

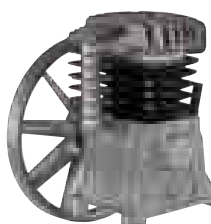

- Superior volumetric efficiency
- Cast iron cylinders for longer life
- Fast dissipation of heat through the use after coolers
- High air flow flywheels
- Oil sight glass

BASE, LINE, PRO & ADVANCED SERIES

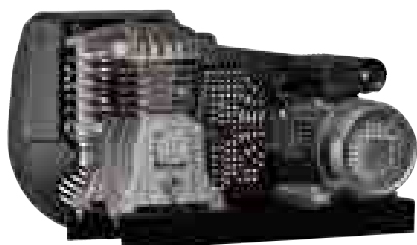

Base plate compressors

A range of base plate and base mounted lubricated belt driven compressor. Available in Line, Pro and Advance series variants.



Lubricated compressors

Pumping units with cast iron lined and cast iron cylinders, provide excellent wear resistance guaranteeing a long working life and very high reliability. They are suitable for heavy-duty use and are an ideal work tool for professionals and craftsmen. Some vertical models are also available for applications requiring a small footprint.



Silent compressors

Have been developed to satisfy market demand for compressors that are silenced, reliable, economic and easy to maintain. This new series has been designed to provide the user with a highly reliable product and an excellent price/quality ratio. They are available on a base or on a tank and with an integrated dryer.



Engine driven compressors

The range of engine driven compressors has been developed to offer portable compressed air powered by a Honda petrol engine. Where the need for total mobility is essential these robust, heavy-duty construction, low power consumption air compressor are ideal. Available in highly portable versions these compressors are ideal for commercial, automotive and agricultural applications. Features include self-adjusting acceleration function, easy start-up, cast iron cylinder pump units and rear rubber and front swivel wheels.



Principal characteristics

- High noise reduction
- Forced ventilation
- Integrated control panel (if star-delta start, with electronic board)
- Pumping unit with cast-iron cylinder for a long working life
- Finned manifold for air cooling
- Silencer on suction
- Robust steel guards to added protection (Advanced Series)
- Full accessibility of mechanical parts
- Versions on tank with two fixed rear wheels, two front swivel wheels and a convenient handle for easy transport

Technical data

Direct Drive Piston Compressors Single Phase Oil Free

Design: Direct drive, single phase
Pressure Range: 8 bar
Electric motor: 1.1kW
Voltage: 230V / 50Hz

MODEL	SERIES	START	VOLT	m ³ /min	CFM	KW	HP	RPM	BAR	PSI	TANK	LWA	DIMENSIONS	KG	CODE
CB-OF-6-CF15	C-Base	DOL	230	0.12	4.1	1.1	1.5	3400	8	116	6	97	320x350x310	8	CC55906039NC

Direct Drive Piston Compressors Single Phase Lubricated

Design: Direct drive, single phase
Pressure Range: 8 - 9 bar
Electric motor: 1.1 to 2.2kW
Voltage: 230V / 50Hz

MODEL	SERIES	START	VOLT	m ³ /min	CFM	KW	HP	RPM	BAR	PSI	TANK	LWA	DIMENSIONS	KG	CODE
CB-3-CF2	C-Base	DOL	230	0.19	6.7	1.5	2	2850	8	116	3	90	470x360x530	19	CC55899017NC
CB-24-CM2	C-Base	DOL	230	0.19	6.7	1.5	2	2850	8	116	24	90	610x270x600	25	CC55898878NC
CB-50-CM2	C-Base	DOL	230	0.19	6.7	1.5	2	2850	8	116	50	90	850x330x720	34	CC55898969NC
CB-100-CM2	C-Base	DOL	230	0.19	6.7	1.5	2	2850	8	116	100	90	1000x400x800	44	CC55899249NC
CB-24-CM25	C-Base	DOL	230	0.24	8.4	1.8	2.5	2850	9	130	24	95	610x280x630	28	CC55900391NC
CB-50-CM25	C-Base	DOL	230	0.24	8.4	1.8	2.5	2850	9	130	50	95	850x330x720	37	CC55899660NC
CB-100-CM25	C-Base	DOL	230	0.24	8.4	1.8	2.5	2850	9	130	100	95	1000x400x800	47	CC55899678NC
CB-24-WB3	C-Base	DOL	230	0.34	12	2.2	3	2850	9	130	24	95	600x440x750	34	CC55900383NC
CB-50-CM3	C-Base	DOL	230	0.34	12	2.2	3	2850	9	130	50	95	850x330x720	43	CC55899041NC
CB-100-CM3	C-Base	DOL	230	0.34	12	2.2	3	2850	9	130	100	95	1000x400x800	52	CC55899058NC
CB-50V-CM3	C-Base	DOL	230	0.34	12	2.2	3	2850	9	130	50V	95	550x630x1030	42	CC55900399NC

BASE, LINE, PRO & ADVANCED SERIES

Belt Driven Single Stage Compressors Single & Three Phase Lubricated

Design: Belt Driven, single & three phase
Pressure Range: 10 bar
Electric motor: 1.5 to 2.2 kW
Voltage: 230-400V / 50Hz

MODEL	SERIES	START	VOLT	m ³ /min	CFM	KW	HP	RPM	BAR	PSI	TANK	LWA	DIMENSIONS	KG	CODE
CL28B-25-CM2	C-Line	DOL	230	0.25	8.9	1.5	2	1400	10	145	25	91	770x350x690	38	CC97242549NC
CP28B-25-CM2	C-Pro	DOL	230	0.25	8.9	1.5	2	1400	10	145	25	95	770x350x590	40	CC55895072NC
CL28-50-CM2	C-Line	DOL	230	0.25	8.9	1.5	2	1400	10	145	50	91	850x380x730	39	CC55901999NC
CP28B-50-CM2	C-Pro	DOL	230	0.25	8.9	1.5	2	1400	10	145	50	95	850x380x730	43	CC55894984NC
CL28-100-CM2	C-Line	DOL	230	0.25	8.9	1.5	2	1400	10	145	100	91	1000x400x800	51	CC55902007NC
CP28-100-CM2	C-Pro	DOL	230	0.25	8.9	1.5	2	1400	10	145	100	95	1000x400x800	53	CC55902391NC
CL28-150-CM2	C-Line	DOL	230	0.25	8.9	1.5	2	1400	10	145	150	91	1320x450x920	69	CC55903919NC
CP28-150-CM2	C-Pro	DOL	230	0.25	8.9	1.5	2	1400	10	145	150	95	1320x450x920	71	CC55903999NC
CP28B-50-CM3	C-Pro	DOL	230	0.29	10.4	2.2	3	1620	10	145	50	95	850x380x730	45	CC55900015NC
CA28B-50-CM3	C-Advanced	DOL	230	0.29	10.4	2.2	3	1620	10	145	50	95	850x380x730	47	CC55901127NC
CL28-100-CM3	C-Line	DOL	230	0.29	10.4	2.2	3	1620	10	145	100	91	1000x400x800	54	CC55903143NC
CL28-100-CT3	C-Line	DOL	400	0.29	10.4	2.2	3	1620	10	145	100	91	1000x400x800	54	CC55903647NC
CP28B-100-CM3	C-Pro	DOL	230	0.29	10.4	2.2	3	1620	10	145	100	95	1080x400x800	60	CC55900023NC
CA28B-100-CM3	C-Advanced	DOL	230	0.29	10.4	2.2	3	1620	10	145	100	95	1080x400x800	62	CC55901135NC
CL28-150-CM3	C-Line	DOL	230	0.29	10.4	2.2	3	1620	10	145	150	91	1320x450x920	72	CC55903959NC
CL28-150-CT3	C-Line	DOL	400	0.29	10.4	2.2	3	1620	10	145	150	91	1320x450x920	72	CC55903975NC
CP28B-150-CM3	C-Pro	DOL	230	0.29	10.4	2.2	3	1620	10	145	150	95	1320x450x920	75	CC55900031NC
CA28B-150-CM3	C-Advanced	DOL	230	0.29	10.4	2.2	3	1620	10	145	150	95	1320x450x920	77	CC55901143NC
CA28B-150-CT3	C-Advanced	DOL	400	0.29	10.4	2.2	3	1620	10	145	150	95	1320x450x920	77	CC55901175NC
CP3-100-CT3	C-Pro	DOL	400	0.31	11.1	2.2	3	1400	10	145	100	92	1080x410x850	63	CC55895171NC
CA3-150-CM3	C-Advanced	DOL	230	0.31	11.1	2.2	3	1400	10	145	150	92	1320x450x920	80	CC55901207NC
CA3-150-CT3	C-Advanced	DOL	400	0.31	11.1	2.2	3	1400	10	145	150	92	1320x450x920	80	CC55901247NC
CL28-200-CT3	C-Line	DOL	400	0.29	10.4	2.2	3	1620	10	145	200	91	1450x460x940	87	CC55903983NC
CL28B-200-FM3	C-Line	DOL	230	0.29	10.4	2.2	3	1620	10	145	200	91	1450x460x940	88	CC55879902NC
CP28B-200-CM3	C-Pro	DOL	230	0.29	10.4	2.2	3	1620	10	145	200	95	1450x460x940	90	CC55900039NC
CP3-200-CM3	C-Pro	DOL	230	0.31	11.1	2.2	3	1400	10	145	200	92	1450x460x940	93	CC55894653NC
CP3-200-CT3	C-Pro	DOL	400	0.31	11.1	2.2	3	1400	10	145	200	92	1450x460x940	93	CC55895213NC
CA28B-200-CM3	C-Advanced	DOL	230	0.29	10.4	2.2	3	1620	10	145	200	95	1450x460x940	92	CC55901151NC
CA28B-200-CT3	C-Advanced	DOL	400	0.29	10.4	2.2	3	1620	10	145	200	95	1450x460x940	92	CC55901183NC
CA3-200-CM3	C-Advanced	DOL	230	0.31	11.1	2.2	3	1400	10	145	200	92	1450x460x940	95	CC55901215NC
CA3-200-CT3	C-Advanced	DOL	400	0.31	11.1	2.2	3	1400	10	145	200	92	1450x460x940	95	CC55901255NC
CL28B-270-CM3	C-Line	DOL	230	0.29	10.4	2.2	3	1620	10	145	270	91	1550x570x1120	106	CC55900247NC
CL3-270-CT3	C-Line	DOL	400	0.31	11.1	2.2	3	1400	10	145	270	92	1550x570x1120	108	CC55896393NC
CP3-270-CM3	C-Pro	DOL	230	0.31	11.1	2.2	3	1400	10	145	270	92	1550x570x1120	111	CC55896419NC
CP3-270-CT3	C-Pro	DOL	400	0.31	11.1	2.2	3	1400	10	145	270	92	1550x570x1120	111	CC55896427NC
CL4-270-FM3	C-Line	DOL	230	0.42	14.9	2.2	3	1100	10	145	270	95	1550x570x1120	114	CC55904199NC
CP4-270-FT3	C-Pro	DOL	400	0.42	14.9	2.2	3	1100	10	145	270	97	1550x570x1120	114	CC55901975NC
CA4-270-FT3	C-Advanced	DOL	400	0.42	14.9	2.2	3	1100	10	145	270	97	1550x570x1120	116	CC55900887NC

Belt Driven Two Stage Compressors

Three Phase Lubricated

Design: Belt driven, three phase

Pressure Range: 10 - 11 bar

Electric motor: 3 to 11 kW

Voltage: 400V / 50Hz

MODEL	SERIES	START	VOLT	m ³ /min	CFM	KW	HP	RPM	BAR	PSI	TANK	LWA	DIMENSIONS	KG	CODE
CL4-200-FT4	C-Line	DOL	400	0.54	19.1	3	4	1400	10	145	200	95	1450x500x1070	96	CC97242564NC
CP4-200-FT4	C-Pro	DOL	400	0.54	19.1	3	4	1400	10	145	200	97	1450x500x1070	100	CC55895270NC
CP4-200-CT4	C-Pro	DOL	400	0.54	19.1	3	4	1400	10	145	200	97	1450x500x1070	102	CC55895056NC
CA4-200-FT4	C-Advanced	DOL	400	0.54	19.1	3	4	1400	10	145	200	97	1450x500x1070	102	CC55901295NC
CL4-270-CT4	C-Line	DOL	400	0.54	19.1	3	4	1400	10	145	270	95	1550x570x1120	116	CC55876015NC
CL4-270-FT4	C-Line	DOL	400	0.54	19.1	3	4	1400	10	145	270	95	1550x570x1120	113	CC97239214NC
CP4-270-CT4	C-Pro	DOL	400	0.54	19.1	3	4	1400	10	145	270	97	1550x570x1120	120	CC55895296NC
CL5-200-CT55	C-Line	DOL	400	0.61	21.4	4	5.5	1400	11	159	200	95	1550x570x1200	139	CC55876023NC
CL5-200-FT55	C-Line	DOL	400	0.61	21.4	4	5.5	1400	11	159	200	95	1450x500x1070	119	CC55896054NC
CP5-200-FT55	C-Pro	DOL	400	0.61	21.4	4	5.5	1400	11	159	200	97	1450x500x1070	124	CC55895346NC
CP5-200-CT55	C-Pro	DOL	400	0.61	21.4	4	5.5	1400	11	159	200	97	1450x500x1070	126	CC55895320NC
CA5-200-FT55	C-Advanced	DOL	400	0.61	21.4	4	5.5	1400	11	159	200	97	1450x500x1070	126	CC55901335NC
CL5-270-CT55	C-Line	DOL	400	0.61	21.4	4	5.5	1400	11	159	270	95	1550x570x1200	139	CC55876023NC
CL5-500-FT55	C-Line	DOL	400	0.61	21.4	4	5.5	1400	11	159	500	95	2030x680x1310	205	CC97247704NC
CA5-500-FT55 SDS	C-Advanced	SDS	400	0.61	21.4	5.5	7.5	1400	11	159	500	97	2030x680x1310	235	CC55904991NC
CA6-270-CT55	C-Advanced	DOL	400	0.61	21.4	5.5	7.5	1400	11	159	270	97	2030x680x1310	218	CC55901359NC
CA6-270-FT55	C-Advanced	DOL	400	0.66	23.2	4	5.5	1150	11	159	270	97	1550x570x1200	143	CC55901391NC
CP6-200-FT75	C-Pro	DOL	400	0.80	28.2	5.5	7.5	1400	11	159	200	97	1450x500x1070	131	CC55904735NC
CA6-200-FT75	C-Advanced	DOL	400	0.80	28.2	5.5	7.5	1400	11	159	200	97	1450x500x1070	132	CC55904743NC
CP6-270-FT75	C-Pro	DOL	400	0.80	28.2	5.5	7.5	1400	11	159	270	97	1550x570x1200	148	CC55895601NC
CP6-500-CT75	C-Pro	DOL	400	0.80	28.2	5.5	7.5	1400	11	159	500	97	2030x680x1310	222	CC55895627NC
CA6-270-CT75	C-Advanced	DOL	400	0.80	28.2	5.5	7.5	1400	11	159	270	97	1550x570x1200	153	CC55901375NC
CL5-500-FT75	C-Line	DOL	400	0.61	21.4	5.5	7.5	1400	11	159	500	95	2030x680x1310	211	CC55904943NC
CL10-270-FT10	C-Line	DOL	400	1.25	44.1	7.5	10	1320	11	159	270	97	1550x570x1200	166	CC55896245NC
CL10-270-FT10 SDS	C-Line	SDS	400	1.25	44.1	7.5	10	1320	11	159	270	97	1550x570x1200	166	CC55904223NC
CP10-270-FT10	C-Pro	DOL	400	1.25	44.1	7.5	10	1320	11	159	270	97	1550x570x1200	176	CC55895700NC
CP10-270-FT10 SDS	C-Pro	SDS	400	1.25	44.1	7.5	10	1320	11	159	270	97	1550x570x1200	193	CC55897466NC
CL10-500-FT10	C-Line	DOL	400	1.25	44.1	7.5	10	1320	11	159	500	97	2030x680x1310	236	CC55880223NC
CA6-500-FT10	C-Advanced	DOL	400	0.80	28.2	7.5	10	1400	11	159	500	97	2030x680x1310	234	CC55905023NC
CL10-900-FT10	C-Line	DOL	400	1.25	44.1	7.5	10	1320	11	159	900	97	2120x900x1580	326	CC55900407NC
CA15-500-FT155	C-Advanced	DOL	400	1.51	53.2	11	15	1320	11	159	500	97	2030x680x1310	258	CC55895759NC
CA15-500-FT155 SDS	C-Advanced	SDS	400	1.51	53.2	11	15	1320	11	159	500	97	2030x680x1310	275	CC55897821NC
CA15-900-FT155	C-Advanced	DOL	400	1.51	53.2	11	15	1320	11	159	900	97	2120x900x1580	348	CC55895575NC
CA15-900-FT155 SDS	C-Advanced	SDS	400	1.51	53.2	11	15	1320	11	159	900	97	2120x900x1580	365	CC55900735NC

BASE, LINE, PRO & ADVANCED SERIES

Belt Driven Tandem Compressors Single & Three Phase Lubricated

Design: Belt Driven, single & three phase
Pressure Range: 11 bar
Electric motor: 4.4 to 22 kW
Voltage: 230-400V / 50Hz

MODEL	SERIES	START	VOLT	m ³ /min	CFM	KW	HP	RPM	BAR	PSI	TANK	LWA	DIMENSIONS	KG	CODE
CL4-300-FM3 TD	C-Line	DOL	230	0.85	29.9	2.2 + 2.2	3 + 3	1100	11	159	300	95	1700x570x1120	150	CC55904703NC
CP4-300-FM3 TD	C-Pro	DOL	230	0.85	29.9	2.2 + 2.2	3 + 3	1400	11	159	300	95	1700x570x1120	160	CC55904383NC
CA4-300-FT4 TD	C-Advanced	DOL	400	1.08	38.3	3 + 3	4 + 4	1400	11	159	300	95	1700x570x1120	164	CC55904727NC
CL5-500-FT55 TD	C-Line	DOL	400	1.20	42.5	4 + 4	5.5 + 5.5	1400	11	159	500	95	2030x680x1310	270	CC55883656NC
CP5-500-FT55 TD	C-Pro	DOL	400	1.20	42.5	4 + 4	5.5 + 5.5	1400	11	159	500	97	2030x680x1310	280	CC55895809NC
CA5-500-FT55 TD	C-Advanced	DOL	400	1.20	42.5	4 + 4	5.5 + 5.5	1400	11	159	500	97	2030x680x1310	284	CC55901463NC
CP6-500-FT75 TD	C-Pro	DOL	400	1.60	56.4	5.5 + 5.5	7.5 + 7.5	1400	11	159	500	97	2030x680x1310	300	CC55895841NC
CA6-500-FT75 TD	C-Advanced	DOL	400	1.60	56.4	5.5 + 5.5	7.5 + 7.5	1400	11	159	500	97	2030x680x1310	304	CC55890147NC
CP6-900-FT75 TD	C-Pro	DOL	400	1.60	56.4	5.5 + 5.5	7.5 + 7.5	1400	11	159	900	97	2120x900x1580	390	CC55895866NC
CA6-900-FT75 TD	C-Advanced	DOL	400	1.60	56.4	5.5 + 5.5	7.5 + 7.5	1400	11	159	900	97	2120x900x1580	394	CC55901479NC
CA10-500-FT10 TD	C-Advanced	DOL	400	2.49	88.1	7.5 + 7.5	10 + 10	1320	11	159	500	97	2030x680x1310	361	CC55895882NC
CL10-900-FT10 TD	C-Line	DOL	400	2.49	88.1	7.5 + 7.5	10 + 10	1320	11	159	900	97	2120x900x1580	431	CC97241780NC
CA10-900-FT10 TD	C-Advanced	DOL	400	2.49	88.1	7.5 + 7.5	10 + 10	1320	11	159	900	97	2120x900x1580	451	CC55895890NC
CP15-900-FT155 TD	C-Pro	DOL	400	3.01	106.4	11 + 11	15 + 15	1320	11	159	900	97	2120x900x1580	475	CC55895916NC

Belt Driven Vertical Receiver Compressors Single & Three Phase Lubricated

Design: Belt Driven, single & three phase
Pressure Range: 10 - 11 bar
Electric motor: 2.2 to 7.5 kW
Voltage: 230-400V / 50Hz

MODEL	SERIES	START	VOLT	m ³ /min	CFM	KW	HP	RPM	BAR	PSI	TANK	LWA	DIMENSIONS	KG	CODE
CA3-150V-FM3	C-Advanced	DOL	230	0.31	11.1	2.2	3	1400	10	145	150V	92	770x560x1690	90	CC55901923NC
CA3-150V-FT3	C-Advanced	DOL	400	0.31	11.1	2.2	3	1400	10	145	150V	92	770x560x1690	90	CC55901431NC
CA4-150V-FT4	C-Advanced	DOL	400	0.54	19.1	3	4	1400	10	145	150V	97	770x560x1690	99	CC55901439NC
CA5-270V-FT55	C-Advanced	DOL	400	0.61	21.4	4	5.5	1400	11	159	270V	97	900x630x1950	151	CC55901447NC
CA6-270V-FT75	C-Advanced	DOL	400	0.80	28.2	5.5	7.5	1400	11	159	270V	97	900x630x1950	158	CC55901455NC

Belt Driven Base Mounted Compressors

Single Phase Lubricated

Design: Belt Driven, single & three phase
Pressure Range: 10 - 11 bar
Electric motor: 1.5 to 11 kW
Voltage: 230-400V / 50Hz

MODEL	SERIES	START	VOLT	m ³ /min	CFM	KW	HP	RPM	BAR	PSI	TANK	LWA	DIMENSIONS	KG	CODE
CA28B-BP-FM2	C-Advanced	DOL	230	0.25	8.9	1.5	2	1400	10	145	Base Plate	95	700x360x400	27	CC55901487NC
CA3-BP-FM3	C-Advanced	DOL	230	0.31	11.1	2.2	3	1400	10	145	Base Plate	92	700x400x480	32	CC55901495NC
CA3-BP-FT3	C-Advanced	DOL	400	0.31	11.1	2.2	3	1400	10	145	Base Plate	92	700x400x480	32	CC55901511NC
CA4-BP-FT4	C-Advanced	DOL	400	0.54	19.1	3	4	1400	10	145	Base Plate	97	840x420x520	40	CC55901519NC
CA5-BP-FT55	C-Advanced	DOL	400	0.61	21.4	4	5.5	1400	11	159	Base Plate	97	1050x550x650	70	CC55901527NC
CP5-BM-FT75	C-Pro	DOL	400	0.80	28.2	5.5	7.5	1400	11	159	Base Mount	97	1050x550x650	81	CC55900439NC
CA6-BP-FT75	C-Advanced	DOL	400	0.80	28.2	5.5	7.5	1400	11	159	Base Plate	97	1050x550x650	78	CC55901535NC
CA6-BM-FT75	C-Advanced	DOL	400	0.80	28.2	5.5	7.5	1400	11	159	Base Mount	97	1050x550x650	83	CC55901543NC
CP10-BP-FT10	C-Pro	DOL	400	1.25	44.1	7.5	10	1320	11	159	Base Plate	97	1050x550x650	104	CC55896351NC
CP10-BM-FT10	C-Pro	DOL	400	1.25	44.1	7.5	10	1320	11	159	Base Mount	97	1050x550x650	109	CC55900447NC
CP15-BP-FT155	C-Pro	DOL	400	1.51	53.2	11	15	1320	11	159	Base Mount	97	1050x550x650	116	CC55900455NC
CA15-BP-FT155	C-Advanced	DOL	400	1.51	53.2	11	15	1320	11	159	Base Plate	97	1050x550x650	116	CC55896369NC

Belt Driven 15 Bar Compressors

Three Phase Lubricated

Design: Belt Driven, three phase
Pressure Range: 15 bar
Electric motor: 4 to 11 kW
Voltage: 400V / 50Hz

MODEL	SERIES	START	VOLT	m ³ /min	CFM	KW	HP	RPM	BAR	PSI	TANK	LWA	DIMENSIONS	KG	CODE
CA5-270-15-FT55	C-Advanced	DOL	400	0.43	15.3	4	5.5	1000	15	218	270	97	1550x570x1200	143	CC55904303NC
CA6-270-15-FT75	C-Advanced	DOL	400	0.57	20.1	5.5	7.5	1000	15	218	270	97	1550x570x1200	150	CC55903639NC
CA10-500-15-FT10	C-Advanced	DOL	400	0.94	33.3	7.5	10	1000	15	218	500	97	2030x680x1310	246	CC55900431NC
CA10-500-15-FT10 SDS	C-Advanced	SDS	400	0.94	33.3	7.5	10	1000	15	218	500	97	2030x680x1310	263	CC55900847NC
CA10-BM-15-FT10	C-Advanced	DOL	400	0.94	33.3	7.5	10	1400	15	218	Base Mount	97	1050x550x650	109	CC55901767NC
CA15-500-15-FT155 SDS	C-Advanced	SDS	400	1.14	40.3	11	15	1000	15	218	500	97	2030x680x1310	275	CC55900839NC
CS10-15-FT75	C-Silenced	DOL	400	0.57	20.2	5.5	7.5	1400	15	218	Floor	90	960x660x800	165	CC55905063NC
CS6-500-15-FT75 SDS	C-Silenced	SDS	400	0.57	20.2	5.5	7.5	1400	15	218	500	90	2120x900x1580	289	CC55905039NC

BASE, LINE, PRO & ADVANCED SERIES

Belt Driven Engine Driven Compressors Honda Petrol

Design: Belt Driven, portable
Pressure Range: 10 bar
Engine: 4 to 9 HP

MODEL	SERIES	START	VOLT	m ³ /min	CFM	KW	HP	RPM	BAR	PSI	TANK	LWA	DIMENSIONS	KG	CODE
CA3-11+11-C4	C-Engine	-	Honda	0.30	10.5	3	4	1310	10	145	11+11	97	750x700x700	63	CC55900463NC
CA4-100-C55	C-Engine	-	Honda	0.42	14.9	4	5.5	1100	10	145	100	97	1080X400X800	82	CC55900495NC
CA4-150-C55	C-Engine	-	Honda	0.42	14.9	4	5.5	1100	10	145	150	97	1320x500x1030	97	CC55904207NC
CA4-200-C55	C-Engine	-	Honda	0.42	14.9	4	5.5	1100	10	145	200	97	1450x500x1070	107	CC55900519NC
CA5-270-C9	C-Engine	-	Honda	0.56	19.7	7.1	9	1300	10	145	270	97	1550X570X1200	160	CC55900503NC
CA6-270-C9	C-Engine	-	Honda	0.68	24.1	7.1	9	1200	10	145	270	97	1550X570X1200	165	CC55900511NC

Belt Driven Silenced Compressors Single & Three Phase Lubricated

Design: Belt Driven, single & three phase
Pressure Range: 10 - 11 bar
Electric motor: 2.2 to 11 kW
Voltage: 230-400V / 50Hz

MODEL	SERIES	START	VOLT	m ³ /min	CFM	KW	HP	RPM	BAR	PSI	TANK	LWA	DIMENSIONS	KG	CODE
CS3-24-FM3	C-Silenced	DOL	230	0.31	11.1	2.2	3	1400	10	145	24	62	840x600x1140	104	CC55903823NC
CS3-24-FT3	C-Silenced	DOL	400	0.31	11.1	2.2	3	1400	10	145	24	62	840x600x1140	104	CC55903831NC
CS3-200-CM3	C-Silenced	DOL	230	0.31	11.1	2.2	3	1400	11	159	200	62	1550x750x1510	154	CC55904623NC
CS3-200-FT3	C-Silenced	DOL	400	0.31	11.1	2.2	3	1400	11	159	200	62	1550x750x1510	152	CC55904647NC
CS4-FT4	C-Silenced	DOL	400	0.54	19.1	3	4	1400	10	145	Floor	68	840x640x910	112	CC55901631NC
CS4-200-FT4	C-Silenced	DOL	400	0.54	19.1	3	4	1400	11	159	200	68	1550x750x1510	160	CC55904671NC
CS5-270-FT55	C-Silenced	DOL	400	0.61	21.4	4	5.5	1400	11	159	270	70	1550x750x1510	225	CC97254197NC
CS6-FT55	C-Silenced	DOL	400	0.66	23.2	4	5.5	1150	11	159	Floor	70	960x660x800	153	CC55903839NC
CS6-270-FT55	C-Silenced	DOL	400	0.66	23.2	4	5.5	1150	11	159	270	70	1550x750x1510	228	CC55903847NC
CS6-FT75	C-Silenced	DOL	400	0.80	28.2	5.5	7.5	1400	11	159	Floor	70	960x660x800	165	CC97249528NC
CS6-270-FT75	C-Silenced	DOL	400	0.80	28.2	5.5	7.5	1400	11	159	270	70	1550x750x1510	240	CC97249502NC
CS10-FT10	C-Silenced	DOL	400	1.25	44.1	7.5	10	1320	11	159	Floor	72	1040x740x870	190	CC97249536NC
CS10-FT10 SDS	C-Silenced	SDS	400	1.25	44.1	7.5	10	1320	11	159	Floor	72	1040x740x870	194	CC97249593NC
CS10-500-FT10	C-Silenced	DOL	400	1.25	44.1	7.5	10	1320	11	159	500	72	2120x900x1580	310	CC97249569NC
CS10-500-FT10 SDS	C-Silenced	SDS	400	1.25	44.1	7.5	10	1320	11	159	500	72	2120x900x1580	314	CC97249627NC
CS15-FT155	C-Silenced	DOL	400	1.51	53.2	11	15	1320	11	159	Floor	72	1040x740x870	200	CC97249478NC
CS15-FT155 SDS	C-Silenced	SDS	400	1.51	53.2	11	15	1320	11	159	Floor	72	1040x740x870	204	CC97249486NC
CS15-500-FT155	C-Silenced	DOL	400	1.51	53.2	11	15	1320	11	159	500	72	2120x900x1580	320	CC97249635NC
CS15-500-FT155 SDS	C-Silenced	SDS	400	1.51	53.2	11	15	1320	11	159	500	72	2120x900x1580	324	CC97249494NC

Belt Driven Silenced Compressors + Refrigerated Dryer

Three Phase Lubricated

Design: Belt Driven, three phase
Pressure Range: 11 bar
Electric motor: 4 to 11 kW
Voltage: 400V / 50Hz

MODEL	SERIES	START	VOLT	m ³ /min	CFM	KW	HP	RPM	BAR	PSI	TANK	LWA	DIMENSIONS	KG	CODE
CS5-270-E-FT55	C-Silenced	DOL	400	0.61	21.4	4	5.5	1400	11	159	270	70	1550x750x1510	255	CC55902263NC
CS6-270-E-FT75	C-Silenced	DOL	400	0.80	28.2	5.5	7.5	1400	11	159	270	70	1550x750x1510	270	CC55902367NC
CS10-500-E-FT10	C-Silenced	DOL	400	1.25	44.1	7.5	10	1320	11	159	500	72	2120x900x1580	340	CC55880181NC
CS10-500-E-FT10 SDS	C-Silenced	SDS	400	1.25	44.1	7.5	10	1320	11	159	500	72	2120x900x1580	344	CC97254213NC
CS15-500-E-FT155	C-Silenced	DOL	400	1.51	53.2	11	15	1320	11	159	500	72	2120x900x1580	350	CC55880165NC
CS15-500-E-FT155 SDS	C-Silenced	SDS	400	1.51	53.2	11	15	1320	11	159	500	72	2120x900x1580	354	CC55880157NC

SERVICE KITS PISTON COMPRESSORS

C-Base, C-Line, C-Advanced, C-Pro, C-Engine series

MODEL RANGES	GASKET KIT CODE	VALVE PLATE KIT CODE	INTAKE FILTER CODE	NRV CODE	OIL
CA3 ; CL3 ; CS3	CC55886980NC	CC91894881NC	CC55875132NC	CC55894513NC	SAE40
CA4 ; CP4 ; CS4	CC92060037NC	CC97155576NC	CC55875132NC	CC55894513NC	SAE40
CA5 ; CL5	CC55893648NC	CC55893622NC	CC55898936NC	CC55894521NC	SAE40
CA6; CP6 ; CS6	CC97241376NC	CC97159594NC	CC55898936NC	CC55894521NC	SAE40
CA10 ; CL10 ; CP10 ; CS10	CC55893655NC	CC55894133NC	CC55898936NC	CC55894521NC	SAE40
CA15 ; CP15 ; CS15	CC55894224NC	CC55894141NC	CC55898936NC	CC55894521NC	SAE40
CA28 ; CL28 ; CP28	CC97251615NC	CC91894881NC	CC55875140NC	CC97160634NC	SAE40
CB-100-CM2 CB-24-CM2 CB-3-CF2 CB-50-CM2	CC55899108NC	CC55899090NC	CC55899132NC	CC97160634NC	SAE40
CB-100-CM3 CB-24-WB3 CB-50-CM3 CB-50V-CM3	CC55899405NC	CC55899090NC	CC55899132NC	CC55904375NC	SAE40
CB-100-CM25 CB-24-CM25 CB-50-CM25		CC55899090NC	CC55890079NC	CC97160634NC	SAE40
CB6			CC55890087NC		SAE40

Only the following lubricants are allowed to be used

- SAE40 - Viscosity 100

- CM** Portable Single Phase
- CT** Portable 3 Phase
- FM** Static Single Phase
- FT** Static 3 Phase
- PM** Carry Single Phase
- CF** Carry Frame Design
- WB** Wheel Barrow Design
- BP** Base Plate
- BM** Base Mount

- SDS** Start Delta Start
- TD** Tandem (Electric Cabinet)
- E** Refrigerated Dryer

Champion have over 420 models in the range - contact the sales team for other variants

Optional SDS electric panel available

All capacities shown are displacement figures

Alternative frequency of 60Hz - specific on order

CC55906079NC Dumper Tandem Piston Comp type80-4pz

Optional Rubber Mounts

RECIPROCATING CAST IRON COMPRESSORS

1.1 - 7.5 kW

- High efficiency 400V/3 phase/50Hz IP55 electric motor
- Belt driven
- Cast iron cylinder with cooling fins and special aluminium alloy cylinder heads
- Pressure range 8 - 15 bar
- Electric motor 1.5kW - 7.5kW
- Tank 80 - 500 litres



TROUBLE FREE AND A LONG SERVICE LIFE

At a glance...



Nominal Pressure
8 - 15 bar g



Motor Power
1.1 - 7.5 kW



Volume Flow
205 - 1657 l/min
7.2 - 58.5 cfm



Power Sound level
68 - 82 dB(A)



Champion, the smart and affordable compressed air solution, make available a range of reciprocating cast iron compressors. Trouble free and with a long service life, these can be used safely in many applications with single and double stage options. Choose from base plate or receiver mounted with 230 volt options on selected models.

Main motor and drive system

- High efficiency 400V/3 phase/50Hz IP55 electric motor
- Special loadless start system
- Automatic discharge system for loadless start
- Belt Driven
- Specially designed fan type pulleys
- Easy tensioning of belt

Compressor block

- Cast iron cylinder with cooling fins and special aluminium alloy cylinder heads
- Specially designed high-speed stainless steel concentric valves
- Cast iron crankcases with high strength
- Dynamically-balanced cast steel crankshaft and counterweight
- Special alloy aluminium pistons and steel cast connecting rods
- Specially designed finger-type, high-capacity stainless steel suction-discharge valves
- Stainless steel suction-discharge valves, specially designed for high pressure strength

Safety systems

- Solenoid discharge valve for loadless start (on models over 4 kW)
- Pressure switch
- Check valve
- Belt pulley guard
- Relief valve
- Easy tensioning of belt

Other features

- CE Certified air tanks complying with SPVD (Simple Pressure Vessel Directive) and designed as per EN 286-1 standard
- Bearings with a long service life
- Air suction filter and silencer
- Impact lubrication system
- Starting panel (For 1.1 - 4 kW models)

Options

- Automatic Condensate Discharge
- Valve for the Air Tank
- Star delta motor starting panel (5.5-7.5 kW models)



Technical data

Belt Driven Cast Iron Compressors Lubricated Single & Three Phase

Design: Belt Drive, single and three phase
Pressure Range: 8 - 15 bar
Tank: 80 - 500 Litres
Capacity: 7.2 to 58.5 CFM

MODEL	PRESSURE		CAPACITY		MOTOR POWER		VOLT	GAS	DIMENSIONS	WEIGHT	TANK	CODE
	BAR	PSI	L/MIN	SCFM	KW	HP	V	PORT	W x L x H	KG	L	
CPI-80-FM15	8	115	205	7.2	1.1	1.5	230	1/2"	1202 x 426 x 894	93	80	CC1197241
CPI-80-FT15	8	115	205	7.2	1.1	1.5	400	1/2"	1202 x 426 x 894	93	80	CC1197240
CPI-80-FT2	8	115	327	11.5	1.5	2	400	1/2"	1202 x 426 x 914	106	80	CC1197242
CPI-80-FM2	8	115	327	11.5	1.5	2	230	1/2"	1202 x 426 x 914	106	80	CC1197243
CPI-200-FT3	8	115	410	14.5	2.2	3	400	1/2"	1531 x 450 x 1037	135	200	CC1197284
CPI-200-FM3	8	115	410	14.5	2.2	3	230	1/2"	1531 x 450 x 1037	135	200	CC1197285
CPI-250-FT55	8	115	607	21.4	4	5.5	400	1/2"	1830 x 466 x 1145	209	250	CC1197286
CPI-500-FT55	8	115	607	21.4	4	5.5	400	1/2"	1934 x 642 x 1934	281	500	CC1197287
CPI-500-FT75	8	115	1013	35.8	5.5	7.5	400	3/4"	1927 x 664 x 1291	308	500	CC1197288
CPI-500-FT10	8	115	1657	58.5	7.5	10	400	3/4"	1926 x 668 x 1413	390	500	CC1197289
CPI-200-FM2-12	12	175	205	7.2	1.5	2	230	1/2"	1532 x 450 x 983	145	200	CC1197291
CPI-200-FT2-12	12	175	205	7.2	1.5	2	400	1/2"	1532 x 450 x 983	145	200	CC1197290
CPI-250-FT55-15	15	215	507	17.9	4	5.5	400	3/4"	1832 x 474 x 1097	230	250	CC1197292
CPI-500-FT10-12	12	175	856	30.2	7.5	10	400	3/4"	1920 x 658 x 1298	374	500	CC1197293
CPI-500-FT10-15	15	215	828	29.2	7.5	10	400	3/4"	1925 x 669 x 1406	439	500	CC1197294

Base mounted cast iron compressors available on request.
 12 & 15 bar models are 2-stage piston
 CPI-80 models are portable (wheels & handle)

Star Delta Start standard on 7.5 kW models
 Star Delta Start optional on 5.5 kW models
 Base Plate and bare pumps available

ROTARY VANE AIR

ROTARY VANE AIR COMPRESSORS

- Exceptional reliability
- 2 year standard warranty
- Sophisticated simple design
- High quality air
- No gears
- Low noise levels
- No belts
- Direct drive





ROTARY VANE AIR COMPRESSORS

At a glance...

 **Nominal Pressure**
7 - 10 bar

 **Voltage**
50 / 60Hz

 **Volume Flow**
0.12 - 1.27 m³/min



The right compressor for your business

Reliable by Design

Direct drive

No gears. No belts. Up to 100,000+ operating hours due to its simple integral design.

High quality air

Clean, dry and pulse free straight from the outlet means less downstream equipment required.

Slow speed

1450 – 2850 rpm speed operation results in low noise, low stresses and long life.

Common replacement parts

Quick, cost-effective servicing, with minimal downtime.

Guaranteed

2 years standard warranty is now available for total peace of mind on all Champion Vane models.

High quality starter

A high quality starter with a robust control circuit, including over-temperature protection.



Champion Vanes can be combined with membrane dryers and aftercooler kits. (Both solutions are offered as retrofit kits or factory fitted).

The membrane dryer kits integrate perfectly with Champion vanes to provide a compact and efficient air drying and filtration solution. The Dryer kits include: Membrane dryer, after cooler, manual water drain, tap, 0.1 micron & 0.01 micron filters.

The after cooler kits are designed to efficiently cool the outlet air and to reduce moisture. The after cooler kits also include a manual drain tap.

Rotary Vane Air Compressors

Design: Open - fixed speed

Pressure Range: 7 - 10 bar

Electric motor: 1.1 - 7.5kW

CODE	MODEL	VOLTAGE	PHASE	COMPRESSED AIR OUTPUT		MAX. WORKING PRESSURE		MOTOR POWER [kW]	NOISE LEVEL [dB(A)]	DIMENSIONS L x W x H [mm]	WEIGHT [kg]	AIR OUTLET SIZE
				[m ³ /min]	[CFM]	[bar (g)]	[psi (g)]					
501PUTS10-4035D40C	CMPV01 Tripod	400V / 50Hz	3	0.12	4.2	10	145	1.1	62	700 x 270 x 470	41	3/8" F-BSP
501PUTS10-2415D40C	CMPV01 Tripod	230V / 50Hz	1	0.12	4.2	10	145	1.1	62	700 x 270 x 470	41	3/8" F-BSP
501PURS10-4035D40C	CMPV01 RM on a 75 Ltr Tank	400V / 50Hz	3	0.12	4.2	10	145	1.1	62	1,120 x 300 x 730	77	3/8" F-BSP
501PURS10-2415D40C	CMPV01 RM on a 75 Ltr Tank	230V / 50Hz	1	0.12	4.2	10	145	1.1	62	1,120 x 300 x 730	77	3/8" F-BSP
502PUTS10-4035D40C	CMPV02 Tripod	400V / 50Hz	3	0.23	8.1	10	145	2.2	69	700 x 270 x 470	41	3/8" F-BSP
502PUTS10-2415D40C	CMPV02 Tripod	230V / 50Hz	1	0.23	8.1	10	145	2.2	69	700 x 270 x 470	41	3/8" F-BSP
502PURS10-4035D40C	CMPV02 RM on a 75 Ltr Tank	400V / 50Hz	3	0.23	8.1	10	145	2.2	69	1,120 x 300 x 730	77	3/8" F-BSP
502PURS10-2415D40C	CMPV02 RM on a 75 Ltr Tank	230V / 50Hz	1	0.23	8.1	10	145	2.2	69	1,120 x 300 x 730	77	3/8" F-BSP
504PURS10-4035D20C	CMPV04 RM on a 200 Ltr Tank	400V / 50Hz	3	0.57	20.1	10	145	4	73	1,410 x 455 x 990	145	1/2" F-BSP
HR05PR07-4035S10C	CMR05 PR 07 SDS on a 200 Ltr Tank	400V / 50Hz	3	0.92	32.5	7	145	5.5	73	1332 x 568 x 1085	215	1/2" F-BSP
HR05PR10-4035S10C	CMR05 PR 10 SDS on a 200 Ltr Tank	400V / 50Hz	3	0.77	27	10	145	5.5	73	1332 x 568 x 1085	215	1/2" F-BSP
HR07PR07-4035S10C	CMR07 PR 07 SDS on a 200 Ltr Tank	400V / 50Hz	3	1.27	44.7	7	145	7.5	73	1332 x 568 x 1085	215	1/2" F-BSP
HR07PR10-4035S10C	CMR07 PR 10 SDS on a 200 Ltr Tank	400V / 50Hz	3	1.05	37	10	145	7.5	73	1332 x 568 x 1085	215	1/2" F-BSP

AFTER COOLERS AND DRYERS FOR CHAMPION VANES

CODE	DESCRIPTION
ACA-501BD-PC	Aftercooler & dryer kit for 501PURS
ACA-502BD-PC	Aftercooler & dryer kit for 502PURS
ACA-504BD-300C	Aftercooler & dryer kit for 504PURS
ACA-5-BC	Aftercooler kit for 501PURS/502PURS
ACA-504-WEGC	Aftercooler kit for 504PURS

SERVICE KITS	DESCRIPTION
C-AK0102	Annual Service Kit for CMPV01 / CMPV02
C-AK04	Annual Service Kit for CMPV04
C-OK0102	Maintenance kit for every 20000 hours or 5 years for CMPV01 / CMPV02
C-OK04	Maintenance kit for every 20000 hours or 5 years for CMPV04
CC1180033	ChampLube Vane lubricant 1 lt
CC1180033-BOX	ChampLube Vane lubricant 1 lt * (Box of 20 x 1 Litre)
C-MK0507	Service Kit for every 2000h CMR05 / CMR07
C-SK0507	Service Kit for every 4000h CMR05 / CMR07
C-OK0507	Overhaul Service Kit CMR05 / CMR07

* for CMPV04 2 litres needed. * Service intervals are defined by calendar months or operating hours, whichever occurs first. In dirty ambient conditions service interval must be halved.

S SERIES

100% OIL-FREE GUARANTEED

PREMIUM OIL-FREE ROTARY SCROLL COMPRESSORS

- 100% oil-free design
- High reliability
- Continuous operation, 100% duty cycle
- Energy efficient
- Low vibration and sound levels
- Compact design
- Low maintenance due to less moving parts



COMPLETELY OIL LESS TECHNOLOGY



At a glance...

 **Nominal Pressure**
8 - 10 bar g

 **Motor Power**
4 - 15kW

 **Volume Flow**
21.2 - 106 m³/hr

Cutting edge technology development

Committed to developing environmentally friendly solutions, we ensure that our customers meet the demands of climate change legislation - reducing their carbon footprints by cutting energy bills and simply operating more efficiently.

Contaminant free. Risk free. 100% Oil-free

Compressed air purity is crucial for many industry sectors, such as medical, research and biotechnology. The new S-Series of oil-free scroll compressors from Champion does not use any oil anywhere in the compressor and has been certified ISO 8573-1 Class 0 and silicone free, which represents the highest air quality level possible.

In addition to the fulfilment of legal requirements, the oil-free scroll technology reduces the costs of ownership by avoiding oil filter replacements, oil condensate treatment and energy to combat the pressure loss caused by filtration.

CLASS	CONCENTRATION TOTAL OIL (AEROSOL, LIQUID, VAPOUR) MG/M ³
0	As specified by the equipment user or supplier and more stringent than class 1
1	≤ 0.01
2	≤ 0.1
3	≤ 1
4	≤ 5

Compressor configuration

Depending on the application requirements, the versatile S-Series from Champion is available in various kW sizes. The scroll compressor range starts with Simplex units at 4, 6 and 8 kW and the Duplex units with 7, 11 and 15 kW. The compressor design features a very clean, simple and serviceable layout.





Industries with applications requiring oil-free air:

- **Transportation** - traditional and hybrid trucks, transit buses, school buses and trains
- **Medical/Healthcare** - instrument air and breathing air
- **Biotechnology** - laboratory equipment
- **Automotive** - painting
- **Food & Beverage**
- **Electronics**
- **Commercial Printing**
- **Drug Manufacture**

Innovative design

Scroll compression explained

- An orbiting (rotating) scroll and fixed scroll housing are mated to create the compression chambers
- The continual movement of the orbiting scroll moves atmospheric air from the intake toward the center, compressing the air into progressively smaller areas
- The compressed air is directed to the center discharge port of the compressor
- Discharge pressure is accomplished during multiple stages of compression, resulting in a continuous intake suction and discharge

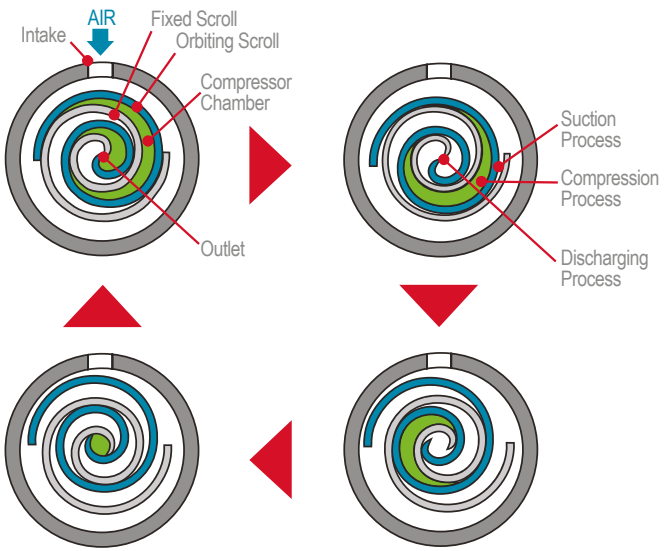

S SERIES

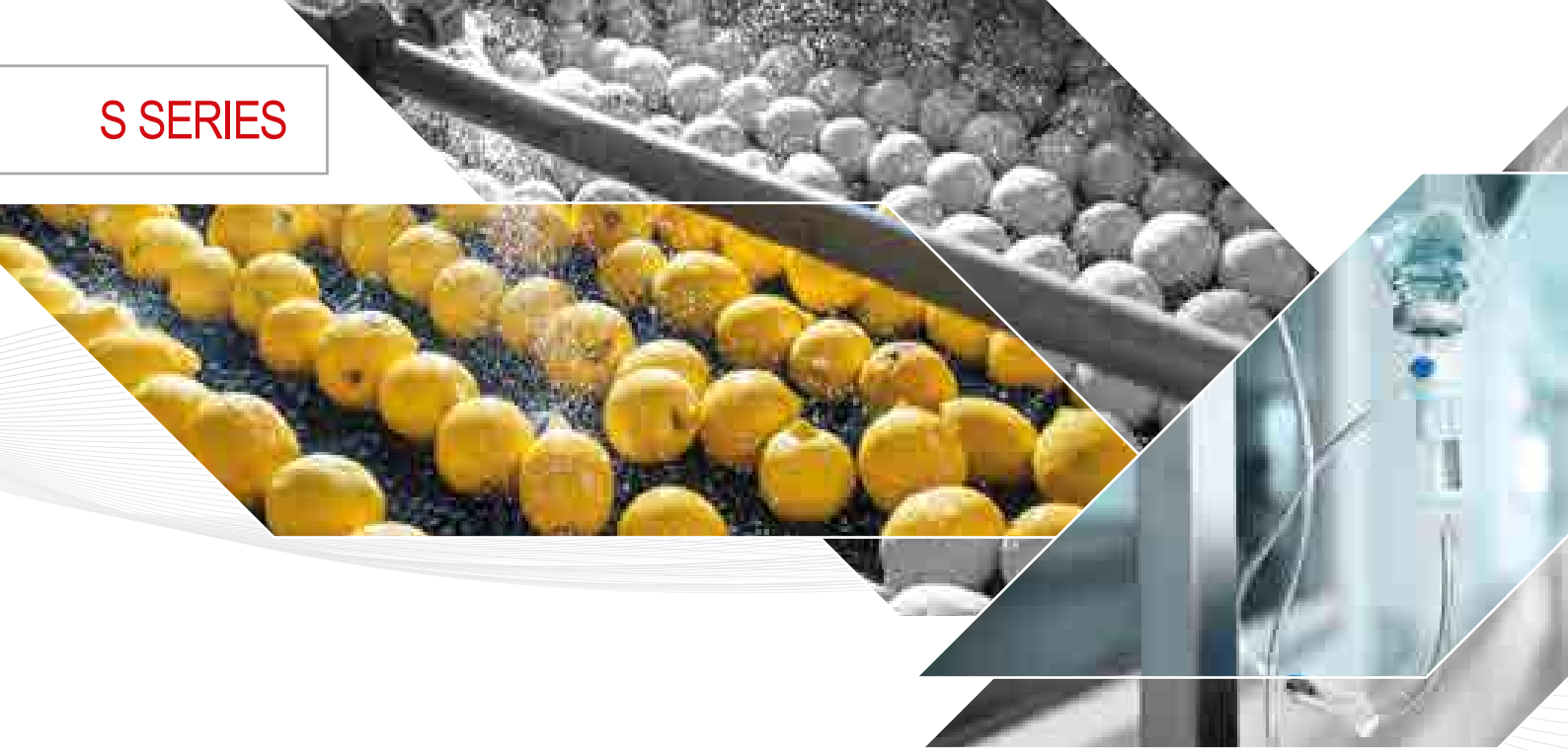

Champion S-Series

- 1 Automatic Condensate Drain
- 2 Rigid Framework
- 3 5 Micron Inlet Filter
- 4 Fork Slots for Easy Handling
- 5 Unique Chambered Design - Maximised Cooling and Serviceability
- 6 Large Industrial Aftercoolers
- 7 Premium Efficient TEFC Motor
- 8 High Volume Cooling Fan
- 9 Low Noise Sound Enclosure
- 10 Internal Vibration Isolators

Duplex



Controlling and monitoring

The S Series from Champion have Deluxe HMI controller as standard. DOL or Soft starter in all variants is available.

The Deluxe HMI control from Champion has easy to use navigation and friendly graphics that deliver interactive and intuitive information at your fingertips.

With a built in integral webserver, via ModBus TCP Ethernet connection, these controllers provide visibility to the scroll compressor system from any computer or mobile device with internet connection.

Deluxe HMI

- 3.5" Full Color Touch Screen
- PLC Controlled
- Lead/Lag Control with Forced Alternation
- System Capacity and Operation Trending
- 26 Language Options
- 24V / DC Power Supply with Fusing
- System Run Time Meter
- Alarm/Fault Log
- System Discharge Pressure
- Pump Discharge Temperature
- System Maintenance Timers
- Integral Webserver
- Modbus TCP Interface over Ethernet

S4 – S8 Simplex Series: Oil free, Scroll compressors

Design: 100% oil free, scroll compressor, belt drive

Pressure Range: from 8 to 10 bar

Electric motor: from 3.7 to 7.5kW

S SERIES	TYPE	S4		S6		S8	
Maximum pressure	bar	8	10	8	10	8	10
Capacity ¹⁾	m ³ /h	23.8	19.6	34.5	26	53.4	41.2
Drive motor IP 55 / class F / IE3	kW	3.7		5.5		7.5	
Volt/Phase/Frequency	400/3/50	400/3/50		400/3/50		400/3/50	
Control voltage	24v	•		•		•	
Acoustic enclosure		•		•		•	
Air Cooled		•		•		•	
Deluxe HMI Controller		•		•		•	

DOL

CODE	CC1216332	CC1216333	CC1216334	CC1216335	CC1216336	CC1216337
------	-----------	-----------	-----------	-----------	-----------	-----------

Soft Start

CODE	CC1216279	CC1216280	CC1216281	CC1216282	CC1216283	CC1216324
------	-----------	-----------	-----------	-----------	-----------	-----------

¹⁾ Data measured and stated in accordance with ISO 1217 Edition 4, Annex C & E at the following conditions: Air Intake Pressure 1 bar a / 14,5 psi; Air Intake Temperature 20° C / 68° F; Humidity 0 % (dry)

S7D – S15D Duplex Series: Oil free, Scroll compressors

Design: 100% oil free, scroll compressor, belt drive

Pressure Range: from 8 to 10 bar

Electric motor: from 7 to 15kW

S SERIES	TYPE	S7D		S11D		S15D	
Maximum pressure	bar	8	10	8	10	8	10
Capacity ¹⁾	m ³ /h	47.6	39.1	69	52	106.8	82.4
Drive motor IP 55 / class F / IE3	kW	7		11		15	
Volt/Phase/Frequency	400/3/50	400/3/50		400/3/50		400/3/50	
Control voltage	24v	•		•		•	
Acoustic enclosure		•		•		•	
Air Cooled		•		•		•	
Deluxe HMI Controller		•		•		•	

DOL

CODE	CC1216338	CC1216339	CC1216340	CC1216341	CC1216342	CC1216343
------	-----------	-----------	-----------	-----------	-----------	-----------

Soft Start

CODE	CC1216326	CC1216327	CC1216328	CC1216329	CC1216330	CC1216331
------	-----------	-----------	-----------	-----------	-----------	-----------

¹⁾ Data measured and stated in accordance with ISO 1217 Edition 4, Annex C & E at the following conditions: Air Intake Pressure 1 bar a / 14,5 psi; Air Intake Temperature 20° C / 68° F; Humidity 0 % (dry)

SERVICE KITS	
CODE	DESCRIPTION
CONFIG_WS	Water Separator Factory Fitted
CONFIG_VOLT	Alternative Voltage 380/3/60
CC1219757	Air Filter (2 Simplex, 4 Duplex)
300SMB6029	Tip Seal Kit S4/S7D (1 Simplex, 2 Duplex)
300SIA6003	Service Kit S6/S11D* (1 Simplex, 2 Duplex)
301SIA6003	Service Kit S8/S15D* (1 Simplex, 2 Duplex)
CC1220854	Brush (2 Simplex, 4 Duplex)
300SMB6022	Grease 80 Grams (Refer to Manual)
300SMB6031	Grease Gun
CC1213688	Air End - Oil Less 3.7 & 5.5 (1 Simplex, 2 Duplex)
CC1213690	Air End - Oil Less 7.5 (1 Simplex, 2 Duplex)

* Service kits include tip seal, face seal & grease

OIL-FREE DENTAL COMPRESSORS

Reliability. Simplicity.
Performance.

- 100% oil-free
- Many variants including open frame, silenced cabinet and membrane dryer
- High reliability
- Low noise levels
- High air quality





CHAMPION

CHAMPION

CHAMPION

CHAMPION

THE DENTAL COMPRESSOR RANGE YOU CAN TRUST

At a glance...



Nominal Pressure
Up to 10 bar



Motor Power
0.8 - 15kW



Volume Flow
Flow @ 5 bar
78 – 1350 L/min



Dental Oil Free Compressors

When compressed air is used in the dental, health, cosmetics sectors or to operate machinery which cannot be contaminated by impurities, an oil-free Champion compressor is required.

Champion oil free compressors are available as open frame, silenced with or without on-board membrane dryer. Due to the high quality filtration and drying system Champion oil free compressors are compliant with HTM2022.

C-PRIME compressors benefit from heavy duty cycle use, silent running, superior design, high reliability, and articulated connecting rod system and brass internal cylinder surface. The entire PRIME range is equipped with hour-counter, thermic protection and amperometric protection. Versions equipped with membrane dryer (M) have a filtration system offering filtration to 0.01 micron, achieving a dew point value of -20°C, producing oil free hygienic air. In addition, the silenced cabinet versions (CS) are among the lowest noise level for this technology.

The comprehensive and innovative range of oil free piston compressors feature:

- Power range from 0.8 to 10 kW
- Suitable for 1-20 dental chairs
- Silenced operation on cabinet versions
- Noise level of 53-78 dB(A)
- Receiver sizes from 24-270 litres
- Efficient and improved duty cycles
- Operating pressure up to 10 Bar
- Double filtration system to 0.01 microns
- Maintenance free membrane dryers to -20°C dew point

In addition, the special internal surface treatment prevents rust generation and air tank corrosion. The installation of a simple automatic drain system reduces the need of periodical ordinary maintenance.

The choice of dental compressor is critical for the correct operating standards of surgeries and laboratories. Actual and future compressed air demand are important questions when making the correct dental compressor choice. The Champion dental compressor range satisfies every need, both from the performance and the investment point of view.



Technical data

C-Prime Open Frame: Oil free, Dental compressors

Design: 100% oil-free, dental piston compressors

Pressure Range: up to 10 bar



CODE	MODEL	CHAIRS	FAD @ 5 BAR			MOTOR POWER			NOISE LEVEL	DIMENSIONS L x W x H	WEIGHT
			[CFM]	[L/ min]	[HP]	[kW]	[V]	[REC]			
CC1189691	C-Prime 30-7 S	1	3.0	85	1	0.75	230	24	65	430 x 400 x 600	29
CC1189692	C-Prime 50-15 S	3	6.0	170	2	1.5	230	40	66	600 x 410 x 770	46
CC1189693	C-Prime 50-25 S	4	8.8	250	3	2.2	230	40	66	600 x 410 x 810	54
CC1189714	C-Prime 100-30 Tandem S	6	12.0	340	4	3	230	90	69	1100 x 600 x 810	97
CC1189715	C-Prime 100-50 Tandem S	8	17.6	500	6	4.4	400	90	69	1100 x 600 x 820	113
CC1189716	C-Prime 200-75 Tandem S	10	25.4	750	9	6.6	400	200	72	1550 x 1000 x 1030	173
CC1189717	C-Prime 270-100 Tandem S	15	31.6	900	13	10	400	270	75	1560 x 1000 x 1030	220
CC1189718	C-Prime 500-150 Tandem S	20	47.4	1350	20	15	400	500	78	1980 x 780 x 1050	330

Models can be configured to 10 Bar maximum pressure offering on average 33% lower FAD @ 8 Bar

C-Prime Silenced Cabinet: Oil free, Dental compressors

Design: 100% oil-free, dental piston compressors

Pressure Range: up to 10 bar



CODE	MODEL	CHAIRS	FAD @ 5 BAR			MOTOR POWER			NOISE LEVEL	DIMENSIONS L x W x H	WEIGHT
			[CFM]	[L/ min]	[HP]	[kW]	[V]	[REC]			
CC1189719	C-Prime 30-15 CS	2	5.9	170	2	1.5	230	40	53	490 x 720 x 890	94
CC1189720	C-Prime 50-25 CS	4	8.8	250	3	2.2	230	40	53	490 x 720 x 890	102
CC1189721	C-Prime 100-30 Tandem CS	6	11.8	340	4	5	230	90	56	1245 x 725 x 1020	210
CC1189722	C-Prime 100-50 Tandem CS	8	17.6	500	6	4.4	400	90	56	1245 x 725 x 1020	220

Models can be configured to 10 Bar maximum pressure offering on average 33% lower FAD @ 8 Bar

DENTAL COMPRESSORS

C-Prime Open Frame with Membrane Dryer: Oil free, Dental compressors

Design: 100% oil-free, dental piston compressors

Pressure Range: up to 10 bar



CODE	MODEL	CHAIRS	FAD @ 5 BAR			MOTOR POWER			NOISE LEVEL [dB(A)]	DIMENSIONS L x W x H [mm]	WEIGHT [kg]
			[CFM]	[L/ min]	[HP]	[kW]	[V]	[REC]			
CC1189725	C-Prime 30-7 SM	1	2.8	78	1	0.75	230	24	65	500 x 470 x 600	36
CC1189726	C-Prime 50-15 SM	3	5.4	152	2	1.5	230	40	66	710 x 410 x 770	50
CC1189727	C-Prime 50-25 SM	4	7.9	225	3	2.2	230	40	66	710 x 410 x 810	58
CC1189728	C-Prime 100-30 Tandem SM	5	10.8	305	4	3	230	90	69	1100 x 630 x 810	102
CC1189729	C-Prime 100-50 Tandem SM	7	15.8	450	6	4.4	400	90	69	1100 x 630 x 820	118
CC1189730	C-Prime 200-75 Tandem SM	9	23.0	660	9	6.6	400	200	72	1450 x 820 x 900	183
CC1189731	C-Prime 270-100 Tandem SM	14	27.5	780	13	10	400	270	75	1560 x 1000 x 1030	240

Models can be configured to 10 Bar maximum pressure offering on average 33% lower FAD @ 8 Bar

C-Prime Silenced Cabinet with Membrane Dryer: Oil free, Dental compressors

Design: 100% oil-free, dental piston compressors

Pressure Range: up to 10 bar



CODE	MODEL	CHAIRS	FAD @ 5 BAR			MOTOR POWER			NOISE LEVEL [dB(A)]	DIMENSIONS L x W x H [mm]	WEIGHT [kg]
			[CFM]	[L/ min]	[HP]	[kW]	[V]	[REC]			
CC1189732	C-Prime 30-15 CSM	2	5.4	152	2	1.5	230	40	53	490 x 720 x 890	98
CC1189733	C-Prime 50-25 CSM	4	7.9	225	3	2.2	230	40	53	490 x 720 x 890	106
CC1189744	C-Prime 100-30 Tandem CSM	5	10.8	305	4	3	230	90	56	1245 x 725 x 1020	215
CC1189745	C-Prime 100-50 Tandem CSM	7	15.8	450	6	4.4	400	90	56	1245 x 725 x 1020	225

Models can be configured to 10 Bar maximum pressure offering on average 33% lower FAD @ 8 Bar



BREATHING AIR COMPRESSORS

Versatile. Reliable.
Flexible.

- Quick charging times
- Safe operation
- Various drive motors
- Easy to use
- High reliability
- Including range of accessories





RELIABLE BREATHING AIR COMPRESSORS

At a glance...



Nominal Pressure
232 - 330 bar



Motor Power
2.2 - 11kW



Volume Flow
80 - 600 L/min



The Range of Breathing Air Compressors

Champion offer a range of breathing air and technical gas compressors from the small portable CBA6 series with a flow rate of 100 l/min and a pressure of 300 bars to the more powerful models for large refilling centres such as the CBA36 with a flow rate of 600 l/min and a maximum pressure of 330 bar.

Compressors such as the CBA36 meet the needs of large refilling centres as it charges a 10 litre single-cylinder at 200 atmospheres in 3.3 minutes with noise levels as low as 75 dB(A). The range is compliant to EN 12021 CGA E.

Champion compressors are available with single and 3-phase electric motors as well as petrol or diesel engines. Additionally, Champion offer a series of important accessories, such as filling panels, transfer hoses, oxygen carbon dioxide and helium analysers, pressure reducers with safety valves and other useful accessories.

POWER RANGE: 2.2 to 11 kW

CAPACITY: 80 to 600 l/min

CHARGE TIME: 3 to 25 mins (based on charging a 10 litre cylinder)

PRESSURE: 232 to 300 bar

NOISE LEVEL: 70 to 101 dB(A)

VOLTAGE: 230 / 1 / 50 / 60, 400 / 3 / 50, 440 / 3 / 60

Technical data

Breathing Air: Compressors - Electric

Design: High pressure piston

Pressure Range: 232 - 300 barg

CODE	MODEL	VARIANT	TYPE	VOLT						CHARGE TIME	DIMENSIONS L x W x H		[dB(A)]	[kg]
					[kW]	[HP]	[L/min]	[cfm]	[Bar]		[mm]			
CC1189900	CBA 6 EM DIN300B	Open	Electric	230/1/50	2.2	3	80	2.8	300	25min	650x350x390	91	39	
CC1189900A	CBA 6 EM DIN232B	Open	Electric	230/1/50	2.2	3	80	2.8	232	25min	650x350x391	91	39	
CC1189900AY	CBA 6 EM YOKE232B	Open	Electric	230/1/50	2.2	3	80	2.8	232	25min	650x350x392	91	39	
CC1189901	CBA 6 ET DIN300B	Open	Electric	400/3/50	3	4	100	3.5	300	20min	650x350x390	95	39	
CC1189901A	CBA 6 ET DIN232B	Open	Electric	400/3/50	3	4	100	3.5	232	20min	650x350x390	95	39	
CC1189901AY	CBA 6 ET YOKE232B	Open	Electric	400/3/50	3	4	100	3.5	232	20min	650x350x390	95	39	
CC1221268	CBA 13 ET SMART DIN300B	Open	Electric	400/3/50	4	5.5	235	8.3	300	8min 30sec	880x480x640	77	117	
CC1221268A	CBA 13 ET SMART DIN232B	Open	Electric	400/3/50	4	5.5	235	8.3	232	8min 30sec	880x480x640	77	117	
CC1221268AY	CBA 13 ET SMART YOKE232B	Open	Electric	400/3/50	4	5.5	235	8.3	232	8min 30sec	880x480x640	77	117	
CC1221270	CBA 13 ET MARK 3 DIN300B	Cabinet	Electric	400/3/50	4	5.5	235	8.3	300	8min 30sec	920x610x880	75	153	
CC1221270A	CBA 13 ET MARK 3 DIN232B	Cabinet	Electric	400/3/50	4	5.5	235	8.3	232	8min 30sec	920x610x880	75	153	
CC1221270AY	CBA 13 ET MARK 3 YOKE232B	Cabinet	Electric	400/3/50	4	5.5	235	8.3	232	8min 30sec	920x610x880	75	153	
CC1221273	CBA 16 ET SMART DIN300B	Open	Electric	400/3/50	5.5	7.5	315	11.1	300	6min 20sec	880x480x640	77	117	
CC1221273A	CBA 16 ET SMART DIN232B	Open	Electric	400/3/50	5.5	7.5	315	11.1	232	6min 20sec	880x480x640	77	117	
CC1221273AY	CBA 16 ET SMART YOKE232B	Open	Electric	400/3/50	5.5	7.5	315	11.1	232	6min 20sec	880x480x640	77	117	
CC1221294	CBA 16 ET MARK 3 DIN300B	Cabinet	Electric	400/3/50	5.5	7.5	315	11.1	300	6min 20sec	920x610x880	75	163	
CC1221294A	CBA 16 ET MARK 3 DIN232B	Cabinet	Electric	400/3/50	5.5	7.5	315	11.1	232	6min 20sec	920x610x880	75	163	
CC1221294AY	CBA 16 ET MARK 3 YOKE232B	Cabinet	Electric	400/3/50	5.5	7.5	315	11.1	232	6min 20sec	920x610x880	75	163	
CC1189906	CBA 22 OPEN DIN300B	Open	Electric	400/3/50	7.5	10	400	14.1	300	5min	790x1025x1545	76	415	
CC1189906A	CBA 22 OPEN DIN232B	Open	Electric	400/3/50	7.5	10	400	14.1	232	5min	790x1025x1545	76	415	
CC1189906AY	CBA 22 OPEN YOKE232B	Open	Electric	400/3/50	7.5	10	400	14.1	232	5min	790x1025x1545	76	415	
CC1189907	CBA 22 SILENCED DIN300B	Cabinet	Electric	400/3/50	7.5	10	400	14.1	300	5min	800x1290x1740	70	420	
CC1189907A	CBA 22 SILENCED DIN232B	Cabinet	Electric	400/3/50	7.5	10	400	14.1	232	5min	800x1290x1740	70	420	
CC1189907AY	CBA 22 SILENCED YOKE232B	Cabinet	Electric	400/3/50	7.5	10	400	14.1	232	5min	800x1290x1740	70	420	
CC1189908	CBA 30 OPEN DIN300B	Open	Electric	400/3/50	9.2	12.5	500	17.7	300	4min	790x1025x1545	76	415	
CC1189908A	CBA 30 OPEN DIN232B	Open	Electric	400/3/50	9.2	12.5	500	17.7	232	4min	790x1025x1545	76	415	
CC1189908AY	CBA 30 OPEN YOKE232B	Open	Electric	400/3/50	9.2	12.5	500	17.7	232	4min	790x1025x1545	76	415	
CC1189909	CBA 30 SILENCED DIN300B	Cabinet	Electric	400/3/50	9.2	12.5	500	17.7	300	4min	800x1290x1740	70	420	
CC1189909A	CBA 30 SILENCED DIN232B	Cabinet	Electric	400/3/50	9.2	12.5	500	18.7	232	4min	800x1290x1740	70	420	
CC1189909AY	CBA 30 SILENCED YOKE232B	Cabinet	Electric	400/3/50	9.2	12.5	500	19.7	232	4min	800x1290x1740	70	420	
CC1189910	CBA 36 OPEN DIN300B	Open	Electric	400/3/50	11	15	600	21.2	300	3min	790x1025x1545	76	415	
CC1189910A	CBA 36 OPEN DIN232B	Open	Electric	400/3/50	11	15	600	21.2	232	3min	790x1025x1545	76	415	
CC1189910AY	CBA 36 OPEN YOKE232B	Open	Electric	400/3/50	11	15	600	21.2	232	3min	790x1025x1545	76	415	
CC1189911	CBA 36 SILENCED DIN300B	Cabinet	Electric	400/3/50	11	15	600	21.2	300	3min	800x1290x1740	70	420	
CC1189911A	CBA 36 SILENCED DIN232B	Cabinet	Electric	400/3/50	11	15	600	21.2	232	3min	800x1290x1740	70	420	
CC1189911AY	CBA 36 SILENCED YOKE232B	Cabinet	Electric	400/3/50	11	15	600	21.2	232	3min	800x1290x1740	70	420	

BREATHING AIR COMPRESSORS



Breathing Air: Compressors - Engine

Design: High pressure piston

Pressure Range: 232 - 300 barg

CODE	MODEL	VARIANT	TYPE	VOLT						CHARGE TIME	DIMENSIONS		
					[kW]	[HP]	[L/min]	[cfm]	[Bar]		L x W x H [mm]	[dB(A)]	[kg]
CC1189912	CBA 6 SH DIN300B	Open	Engine	Honda Petrol	4	5.5	100	3.5	300	20min	780x350x320	101	37
CC1189912A	CBA 6 SH DIN232B	Open	Engine	Honda Petrol	4	5.5	100	3.5	232	20min	780x350x320	101	37
CC1189912AY	CBA 6 SH YOKE232B	Open	Engine	Honda Petrol	4	5.5	100	3.5	232	20min	780x350x320	101	37
CC1221295	CBA ERGO 16 SH DIN300B	Open	Engine	Honda Petrol	6.3	8.4	315	11.1	300	8min 30sec	1130x540x640	96	135
CC1221295A	CBA ERGO 16 SH DIN232B	Open	Engine	Honda Petrol	6.3	8.4	315	11.1	232	8min 30sec	1130x540x640	96	135
CC1221295AY	CBA ERGO 16 SH YOKE232B232	Open	Engine	Honda Petrol	6.3	8.4	315	11.1	232	8min 30sec	1130x540x640	96	135
CC1221296	CBA ERGO 16 LOMBARDINI DIN300B	Open	Engine	Lombardini	6.6	9	315	11.1	300	6min 20sec	1130x540x640	96	135
CC1221296A	CBA ERGO 16 LOMBARDINI DIN232B	Open	Engine	Lombardini	6.6	9	315	11.1	232	6min 20sec	1130x540x640	96	135
CC1221296AY	CBA ERGO 16 LOMBARDINI YOKE232B	Open	Engine	Lombardini	6.6	9	315	11.1	232	6min 20sec	1130x540x640	96	135

Breathing Air: Accessories

CODE	MODEL
CC1189917	CBA 6 Auto Drain Timer
CC1189918	CBA 6 Auto Stop
CC1189919	Safety Valve 330 Bar
CC1189920	Safety Valve 300 Bar
CC1189921	Safety Valve 225 Bar
CC1189922	CBA 6 - Air Filter Cartridge
CC1189923	CBA 13-16 Intake Air Filter Cartridge
CC1189924	CBA 22-36 hyperfilter Filter Cartridge
CC1189925	CBA 22-36 + 13-18 Tropical Oil Filter Cartridge
CC1189926	Breathing Compressor Oil 1/2Lt
CC1189927	Breathing Compressor Oil 1Lt

AVAILABLE VERSIONS

SMART	Basic
MARK 3	Autostop / Auto-drain / Oil level switch / Phase control / Cabin Thermo-switch
VOLTAGE	230 V - 50/60 Hz
	400 V - 50 Hz
	440 V - 60 Hz

CMP- SERIES



ONE STEP AHEAD

PORTABLE SCREW COMPRESSORS

- Mobile compressed air solution
- Independent from power source
- Compact and lightweight
- Low emissions
- Easy to operate
- Energy efficient

**Contact your sales manager or our sales team
for our stand-alone brochure and price list for
model CMP-P21 to CMP-P271TS**



DESIGNED FOR THE MOST DEMANDING CONDITIONS

Champion Portable Compressors

High-precision construction projects demand that the efficiency and reliability of compressors is of the highest calibre. Champion offers a wide range of portable compressors, with a reputation within the industry for just that – compressors that meet the requirements of numerous mobile compressed air applications.

The C-Series from Champion is constantly evolving and guarantees high energy efficiency, low emissions and many other innovations, which make daily operations and maintenance tasks much easier.

Engineering Excellence

Changing emission legislation is a key driver for development, but Champion's passionate engineering team also strive to achieve the best possible performance at the lowest operational costs. The C-Series of portable compressors fulfills the emission standards in accordance with the directive 97/68/EC. Additionally, the compressors are very compact and lightweight which is a preference for many customers.

The screw compression element is the most important component of the compressor. Therefore Champion keeps the design and manufacture in-house, using the latest CNC rotor grinding machinery, coupled with online laser technology. The resulting reliability and performance ensures that operating costs will remain low throughout the life of the compressor.

AirPlus

Tailored compressor solutions to fit your application.

Champion offers numerous options and accessories allowing customers to configure the compressor according to the specific requirements of the application. Besides various components for air treatment, integrated generators, banded bottom boxes, toolboxes, hose reels and integrated oilers, etc. can all be factory fitted.

Champion Genuine Parts

Enjoy complete peace of mind.

Genuine Champion parts and lubricants ensure best performance and reliability is maintained.

- Minimum losses contributing to energy savings
- Long service life, even under harsh conditions
- High reliability



DESIGNED TO LAST



At a glance...

 **Operating Pressure**
6 - 7 bar g

 **Motor Power**
6.3 - 8.7 kW

 **Volume Flow**
0.8 - 1.2 m³/min



Compressor

The Champion range of self-contained compressors uses lubricated screw air ends with high airflow. The progressive adjustment of the airflow constantly maintains an operating pressure between 7 and 8 bar, thus avoiding the use of a cumbersome air tank.

Protection

The "ROLL BAR" system fully protects the compressor and facilitates maintenance. The anti-vibration pads provide excellent stability and limit vibration.

Thermic engine

Our choice of HONDA petrol engines, known for their high reliability and excellent sound levels, guarantees the longevity of our compressors and a great ease of use. The engine speed is reduced automatically when the compressor is not stressed (control valve + pneumatic jack group).

Oil Separator

Our compressors are equipped with an improved cooling system. Temperature control guarantees optimum longevity.

Portable Compressors

CMP Series P6 - B9

Design: Engine Driven Rotary Screw

Pressure Range: 6 - 7 bar

Power Range: 9 - 13 HP

Mobile Fuel Tank: 5.3 - 6.1 Litres

MODEL	FLOW ¹⁾			ADJUSTMENT PRESSURE ³⁾	HONDA PETROL ENGINE		ELECTRIC START-UP BATTERY INCLUDED	PROGRESSIVE ADJUSTMENT OF ENGINE SPEED	SOUND POWER LEVEL LwA ²⁾	MOBILE FUEL TANK	DIMENSIONS		WEIGHT	CODE
	L/M	CFM	m ³ /min		BAR	kW/HP					MODEL	RPM		
CMP-P6R	800	28	0.8	6	6.3/9	GX 270	-	2500 - 3500	97	5.3	820x560x610	69	CC1198063	
CMP-P6	800	28	0.8	7	6.3/9	GX 270	Yes	2500 - 3500	97	5.3	820x560x610	79	CC1198074	
CMP-P7R	1200	42	1.2	7	8.7/13	GX 390	-	2400 - 3500	97	6.1	820x560x610	80	CC1198075	
CMP-P7	1200	42	1.2	7	8.7/13	GX 390	Yes	2400 - 3500	97	6.1	820x560x610	90	CC1198076	
CMP-P8R	800	28	0.8	6	6.3/9	GX 270	-	2500 - 3500	97	5.3	820x560x610	79	CC1198077	
CMP-P8	800	28	0.8	7	6.3/9	GX 270	Yes	2500 - 3500	97	5.3	820x560x610	89	CC1198078	
CMP-P9R	800	28	0.8	7	8.7/13	GX 390	-	2400 - 3500	97	6.1	820x560x610	100	CC1198079	
CMP-P9	1200	42	1.2	7	8.7/13	GX 390	Yes	2400 - 3500	97	6.1	820x560x610	110	CC1198080	
CMP-B8	800	28	0.8	7	6.3/9	GX 270	Yes	2500 - 3500	97	5.3	740x540x530	59	CC1198081	
CMP-B9	1200	42	1.2	7	8.7/13	GX 390	Yes	2500 - 3500	97	6.1	740x540x530	65	CC1198082	

¹⁾ Flow according to CE standard 1217 Annex C. ²⁾ Sound level according to EU 2000/14 Annexe 8. ³⁾ Portable fuel tank with quick coupling marine safety category ⁴⁾ Pressure of 9-12 bar available upon request
Option: Models P8-P9 - static version available - kit consists of 4 AV mounts + 4 mounting plates for commercial vehicles

DESIGNED TO LAST

At a glance...

 **Operating Pressure**
7 - 12 bar g

 **Motor Power**
15.5kW

 **Volume Flow**
1.0 - 1.4 m³/min



The CMP-Series is a powerful alternative to electrical tools

Small, compact and lightweight, at only 165kg weight with 1.4 m³/min at 7 bar. Perfect for a wide-range of repair and installation jobs.

Electric Start as Standard

Easy to start and flexible operation.



Honda GX 630V

Air cooled petrol engine.

Champion Genuine Parts

Enjoy complete peace of mind.

Genuine Champion parts and lubricants ensure best performance and reliability is maintained.

- Minimum losses contributing to energy savings
- Long service life, even under harsh conditions
- High reliability



Larger portables from CMP-P21 through to TurboScrew are available. Contact the Champion Sales Team for more information and brochure.

CMP SERIES	TYPE	CMP-P10	CMP-P12	CMP-P14
CODE		A60141201	A60141001	A60140701
ENGINE		HONDA GX630	HONDA GX630	HONDA GX630
MOTOR POWER	[kW]	15.5	15.5	15.5
OPERATING PRESSURE	[bar g]	12	10	7
	[psi g]	174	145	102
VOLUME FLOW	[m ³ /min]	1.4	1.8	1.8
	[cfm]	50	64	64
ENGINE SPEED OFF LOAD	[rpm]	2200 - 3550		
SOUND POWER LEVEL ¹⁾	[LwA]	97 (dB)		
VOLUME FLOW	[m ³ /min]	1.0	1.4	1.4
	[cfm]	35	50	50
ENGINE SPEED OFF LOAD/LOAD	[rpm]	2200 - 2900		
SOUND POWER LEVEL ¹⁾	[LwA]	93 (dB)		
AIR OUTLET SIZE		1" x 3/4"		
DIMENSIONS L X W X H	[mm]	890 x 635 x 670		
WEIGHT (WITHOUT FUEL)	[Kg]	150		

¹⁾ Legal Limiting values of EC directive acc to 2000/14/EC

SERVICE KITS	DESCRIPTIONS
CC1186378	600 hrs or 6 months compressor service kit C10-C14
CC1186379	Annual engine service kit C10-C14
SCUO2000-5GT3	Lubricant (pack of 3 x 5L)

Champion codes relates to power sound level (LwA) of 97 decibels. Clearly mark on your order if the lower noise level of 93 decibels is required

Champion Portable Compressor Range

CMP-P10-12 TO CMP-P14

At a glance...

-  **Nominal Pressure**
7 - 12 bar g
-  **Engine Power**
15.5 kW
-  **Volume Flow**
1.0 - 1.4 m³/min



CMP-P21 TO CMP-P31

At a glance...

-  **Nominal Pressure**
7 - 12 bar g
-  **Engine Power**
16.5 - 18.9 kW
-  **Volume Flow**
2.0 - 3.0 m³/min



CMP-P36-10 TO CMP-P51

At a glance...

-  **Nominal Pressure**
7 - 10 bar g
-  **Engine Power**
35 kW
-  **Volume Flow**
3.5 - 5.0 m³/min



CMP-P56-14 TO CMP-P77



At a glance...

-  **Nominal Pressure**
7 - 14 bar g
-  **Engine Power**
53.7 kW
-  **Volume Flow**
5.5 - 7.6 m³/min



CMP-P86-14 TO CMP-P141-9

At a glance...

-  **Nominal Pressure**
5 - 14 bar g
-  **Engine Power**
90 - 105 kW
-  **Volume Flow**
8.6 - 13.3 m³/min



CMP-P201TS-24 TO CMP-P271TS-9

At a glance...

-  **Nominal Pressure**
9 - 24 bar g
-  **Engine Power**
180 - 224 kW
-  **Volume Flow**
20 - 27 m³/min



Performance Protection for Portable Compressors

When you buy a Champion C-Series portable compressor, peace of mind comes as standard now. The first of a kind Mobile 5 Warranty offers genuine performance protection for up to 5 years. The main compressor elements and controls¹ are covered at zero additional cost.

Having your compressor serviced by authorised personnel in accordance with Champion's maintenance schedules, ensures you enjoy comprehensive protection for up to 5 years (up to a maximum of 10,000 operating hours).

Mobile 5 from Champion – keeping your workforce working.



¹ Terms, conditions & exclusions apply.

COMPRESSED AIR TREATMENT

- Basic Principals
- Air Filters
- Cyclone Separators
- Refrigeration Dryers
- Adsorption Dryers
- Air Receiver Tanks
- Condensate Drains
- Oil / Water Separators
- Industrial Chillers
- EPL Piping System





Compressed air quality classes according to ISO 8573-1:2010

CLASS	SOLID PARTICLES MAXIMUM NUMBER OF PARTICLES PER CUBIC METER AS A FUNCTION OF PARTICLE SIZE, D ²¹			HUMIDITY AND LIQUID WATER PRESSURE DEW POINT		OIL CONCENTRATION OF TOTAL OIL ²¹ (LIQUID, AEROSOL AND VAPOUR)	
	[0.1 µm < d ≤ 0.5 µm]	[0.5 µm < d ≤ 1.0 µm]	[1.0 µm < d ≤ 5.0 µm]	[°C]	[°F]	[mg/m ³]	[ppm / w / w]
0	As specified by the equipment user or supplier and more stringent than class ¹¹						
1	≤ 20,000	≤ 400	≤ 10	≤ -70	-94	≤ 0.01	≤ 0.008
2	≤ 400,000	≤ 6,000	≤ 100	≤ -40	-40	≤ 0.1	≤ 0.08
3	Not specified	≤ 90,000	≤ 1,000	≤ -20	-4	≤ 1	≤ 0.8
4	Not specified	Not specified	≤ 10,000	≤ +3	38	≤ 5	≤ 4
5	Not specified	Not specified	≤ 100,000	≤ +7	45	Not specified	Not specified
6				≤ ±10	50		
	MASS CONCENTRATION ²¹ - C _p [mg/m ³]			LIQUID WATER CONTENT ²¹ - C _w [g/m ³]			
6	0 < C _p ≤ 5			Not specified			
7	5 < C _p ≤ 10			C _w ≤ 0.5			
8	Not specified			0.5 ≤ C _w ≤ 5			
9	Not specified			Not specified			
X	C _p > 10			> 5			

¹¹ To qualify for a class designation, each size range and particle number within a class shall be met.

²¹ At reference conditions: air temperature of 20° C, absolute air pressure of 100 kPa (1 bar), 0 relative water vapour pressure.

BASIC PRINCIPLES OF MOST TYPICAL COMPRESSED AIR APPLICATION

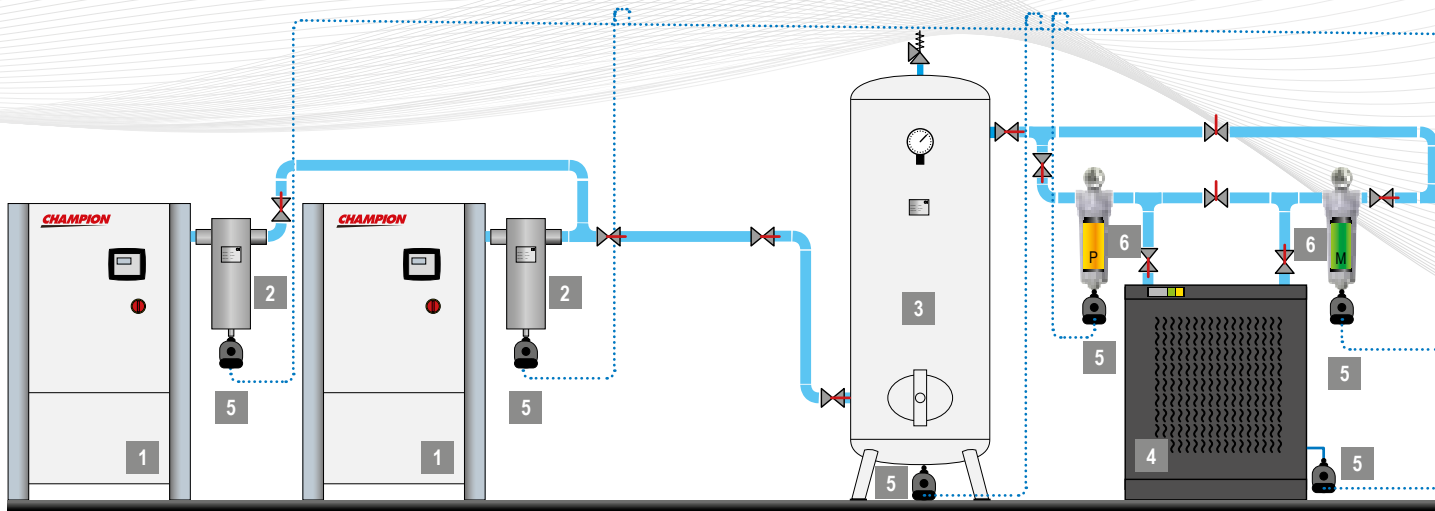

1. Compressor: The basic working principle of an air compressor is to compress atmospheric air, which is then used as per the requirements. In the process, atmospheric air is drawn in through an intake valve; more and more air is pulled inside a limited space mechanically by means of piston, impeller, or vane. Since the amount of pulled atmospheric air is increased in the receiver or storage tank, volume is reduced and pressure is raised automatically. In simpler terms, free or atmospheric air is compressed after reducing its volume and at the same time, increasing its pressure. Champion can provide many types of compressor to suit your needs.

2. Cyclone condensate separator: Cyclone condensate separators use centrifugal motion to force liquid water out of compressed air. The spinning causes the condensate to join together on the centrifugal separators walls when the condensate gains enough mass it falls to the bottom of the separators bowl where it pools in the sump until it is flushed out of the system by the automatic float drain valve. They are installed following aftercoolers to remove the condensed moisture.

3. Pressure vessel: Pressure vessel plays very important role in compressed air system:

- Damping pulsations caused by reciprocating compressors
- Providing a location for free water and lubricant to settle from the compressed air stream
- Supplying peak demands from stored air without needing to run an extra compressor
- Reducing load/unload or start/stop cycle frequencies to help screw compressors run more efficiently and reduce motor starts
- Slowing system pressure changes to allow better compressor control and more stable system pressures

4. Compressed air dryer : Compressed air leaving the compressor aftercooler and moisture separator is normally warmer than the ambient air and fully saturated with moisture. As the air cools the moisture will condense in the compressed air lines. Excessive entrained moisture can result in undesired pipe corrosion and contamination at point of end use. For this reason some sort of air dryer is normally required.

Some end use applications require very dry air, such as compressed air distribution systems where pipes are exposed to winter conditions. Drying the air to dew points below ambient conditions is necessary to prevent ice buildup.

Common types:

- Refrigerant
- Dessicant
- Membrane

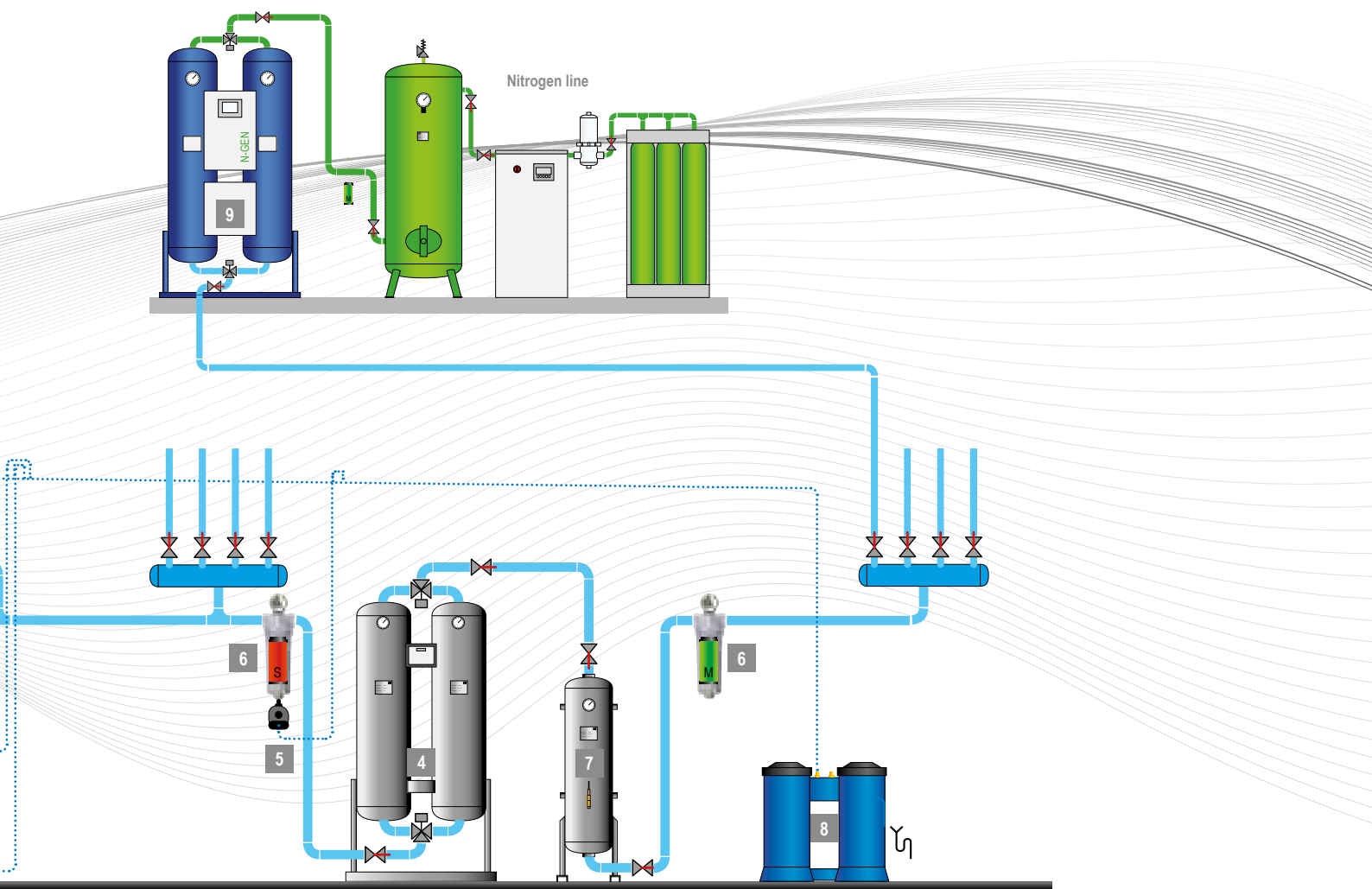

5. Condensate drain: Drains are needed at all separators, filters, dryers and receivers in order to remove the liquid condensate from the compressed air system.

Failed drains can allow slugs of moisture to flow downstream that can overload the air dryer and foul end use equipment.

6. Filter: Compressed air filters are used for high efficient removal of solid particles, water, oil aerosols, hydrocarbons, odour and vapours from compressed air systems.

To meet the required compressed air quality appropriate filter element must be installed into filter housing.

7. Activated carbon tower: Activated carbon tower eliminates hydrocarbon vapours and odours from compressed air. Towers are filled with activated carbon adsorbent that adsorbs contaminants onto the surface of its internal pores. Activated carbon towers are used at applications where content of oil vapours needs to be reduced to minimum.

Activated carbon towers can be incorporated in existing compressed air systems significantly minimising the risks of contamination.

They are able to absorb oil carry-over (both liquid and vapour) to provide the plant with technically oil-free compressed air.

8. Oil/water separator: Local environmental laws and regulations state that condensate drained from compressed air systems cannot be returned to the sewage system due to the content of compressor lubricating oil. Water/oil separators are one of the most effective and economical solution. Multi-stage separation process using oleophilic filters and activated carbon, ensures exceptional performance and trouble free operation.

9. Nitrogen generator: The nitrogen generators extract the available nitrogen in the ambient air from the other gases by applying the Pressure Swing Adsorption (PSA) technology. During the PSA process compressed, cleaned ambient air is led to a molecular sieve bed, which allows the nitrogen to pass through as a product gas, but adsorbs other gases.

End user advice

- Replace inappropriate end use applications with efficient models (vortex nozzles, atomizers)
- Install a flow controller to lower plant pressure and reduce artificial demand caused by higher than required pressures
- Turn off air consuming equipment, using electric solenoids or manual shutoff valves
- Avoid operation of air tools without a load, as this consumes more air than a tool under load
- Replace worn tools, as they often require higher pressure and consume excess compressed air than tools in good shape
- Lubricate air tools as recommended by the manufacturer. Keep air used by all end uses free of condensate in order to maximize tool life and effectiveness
- Where possible and practical, group end use air equipment that has similar air requirements of pressure and air quality

CHF SERIES ALUMINUM COMPRESSED AIR FILTERS

Applications

- General industrial applications
- Automotive
- Electronics
- Food and beverage
- Chemical
- Petrochemical
- Plastics
- Paint

At a glance...



Operating Pressure
17 bar



Connections
3/8" - 3"



Flow Rate
18 - 18247 cfm

The reliability of compressed air filtration is paramount to the ongoing fight against problems caused through contamination entering the air system. Contamination in the form of dirt, oil and water can lead to:

- Pipescale and corrosion within pressure vessels
- Damage to production equipment, air motors, air tools, valves and cylinders
- Premature and unplanned desiccant replacement for adsorption dryers
- Spoiled product

The Champion filtration range offers various products and grades of filtration to provide peace of mind whatever the air quality requirement. It has been designed with focus on reliability and efficiency.

Designed and Built for Exceptional Performance

The advanced compressed air filter range from Champion reduces contamination in your air stream to help protect your critical processes and valuable equipment. These filters are rigorously tested and engineered with superior components to provide years of reliable performance and consistently high-quality air.

The standard for high-quality air

The Champion filter range provides clean, high-quality air as defined by ISO 8573.1:2010 and are certified by a third party under ISO 12500-1.





Compressed Air Purification - The perfect choice!

Water Separation – The CHF Range of water separators

The CHF-range of water separators provide bulk condensed water and liquid oil removal and are used to protect coalescing filters against bulk liquid contamination.

0.5 – 200 m³/min*

18 – 7062 cfm*



Filtration – The CHF Range of compressed air filters

The CHF-range of filters efficiently removes water and oil aerosols, atmospheric dirt and solid particles, rust, pipescale and micro-organisms.

0.5 – 45 m³/min*

18 – 1600 cfm*



Filtration – The CHF Range of flanged filters**

For larger flowrate or higher pressure applications the flanged filters are available in the standard four filtration grades.

48 – 516 m³/min*

1702 – 18247 cfm*

* Flow rate at 20° C, 7 bar

** On request



Compressed air contamination will ultimately lead to:

- ▼ Inefficient production processes
- ▼ Spoiled, damaged or reworked products
- ▼ Reduced production efficiency
- ▼ Increased manufacturing costs

COMPRESSED AIR FILTERS



Superior Filtration Technology

- A** Patented dual indicator (optional accessory) shows differential pressure drop and economical operating efficiency
- B** Patented smooth bore flow insert directs air into the filter element, minimising turbulence and pressure losses
- C** All-aluminum, precision die cast body suitable for 80°C and 17 bar g maximum working pressure applications
- D** Proprietary coating applied to the inside and outside surfaces provides corrosion protection in harsh industrial environments
- E** Filter element with stainless steel mesh withstands high differential pressure while minimizing flow restriction through the element
- F** Ergonomic bowl design with no-touch filter element simplifies element replacement

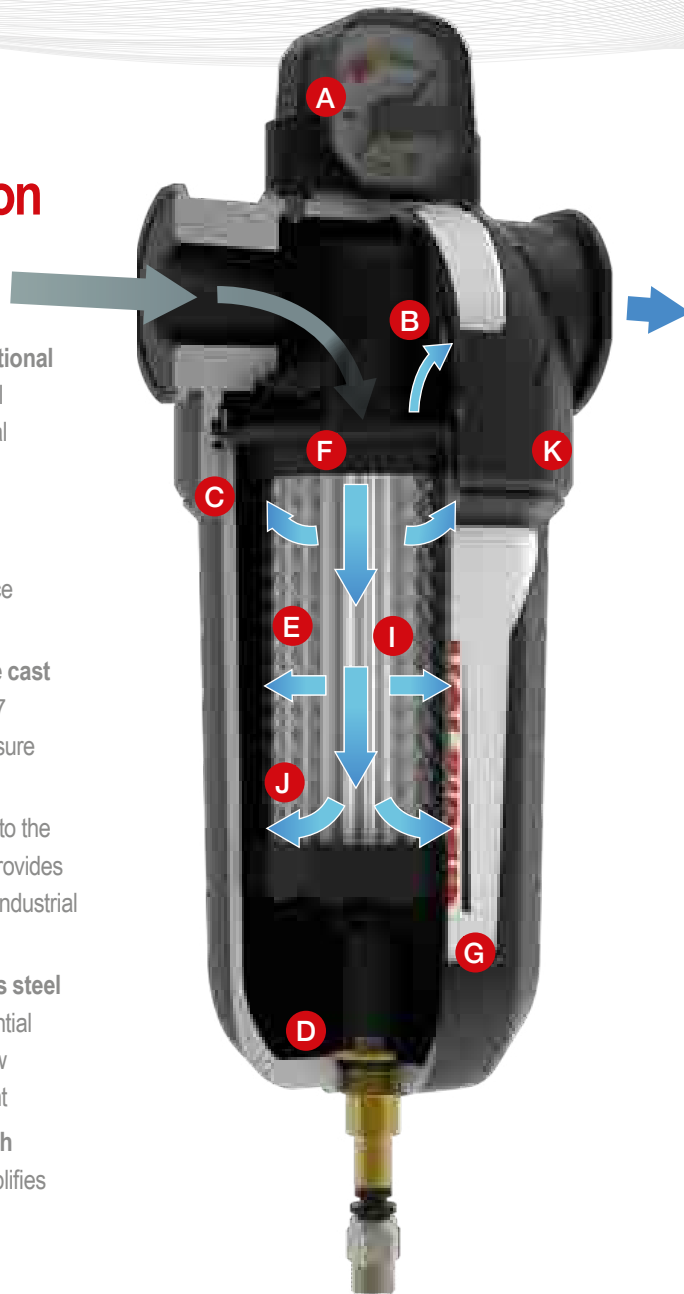

- G** Time strip label indicates when it's time to change the element (CHF Grade only)
- H** Reliable discharge The M and S grade filters and water separators are equipped with internal float drain. The Particulate (R) and Activated Carbon (A) filters have manual drain
- I** Deep-pleated filter media reduces air flow velocity to maximise filtration efficiency and minimise pressure losses
- J** High-efficiency drainage layer improves liquid drainage properties and enhances chemical compatibility
- K** Simple visual alignment of the filter head and bowl ensures accurate assembly of components and helps to improve safety

High efficiency bulk liquid removal

Water separators remove bulk liquids such as condensate, water and liquid oil from the air flow through directional and centrifugal separation. Installed before a coalescing filter the water separator can provide added protection against bulk liquid contamination enabling the filter to operate more efficiently.

The CHF Series water separator range from Champion can operate across various flow conditions and have been optimised to reduce differential pressure with very low maintenance.



Technical Data - Compressed Air Condensate Separators - CHF Series

SEPARATOR MODEL	CHAMPION PART NUMBER [CCN]	CONNECTION SIZE	FLOW RATE		MAX. PRESSURE		DIMENSIONS		WEIGHT [kg]
			[m³/min]	[cfm]	[bar]	[psi]	W [mm]	H [mm]	
CHF005W	47700907001	3/8"	0.50	18	17	250	76	175	0.6
CHF007W	47700908001	1/2"	0.66	23	17	250	76	175	0.6
CHF018W	47700909001	3/4"	1.8	64	17	250	98	230	1.2
CHF040W	47700910001	1"	4.0	141	17	250	129	268	2.2
CHF085W	47700911001	1 1/2"	8.5	300	17	250	129	268	2.1
CHF170W	47700912001	2"	17.0	600	17	250	170	467	5.1
CHF380W	47700913001	3"	38.0	1342	17	250	205	548	20

Technical Data - Compressed Air Filters CHF Series - Grade M

FILTER MODEL	PN	CONNECTION SIZE	FLOW RATE		MAX. PRESSURE		DIMENSIONS		WEIGHT [kg]
			[m³/min]	[cfm]	[bar]	[psi]	W [mm]	H [mm]	
CHF005LM	47698906001	3/8"	0.5	18	17	250	76	225	0.55
CHF007LM	47698907001	1/2"	0.7	24	17	250	76	225	0.55
CHF013LM	47698908001	3/4"	1.3	44	17	250	98	280	1.07
CHF018LM	47698909001	3/4"	1.8	65	17	250	98	280	1.09
CHF025LM	47698910001	1"	2.5	88	17	250	129	319	2.06
CHF032LM	47698911001	1"	3.2	112	17	250	129	319	2.06
CHF038LM	47698912001	1"	3.8	135	17	250	129	319	2.06
CHF067LM	47698913001	1 1/2"	6.7	235	17	250	129	409	2.36
CHF082LM	47698914001	1 1/2"	8.2	288	17	250	129	409	2.36
CHF100LM	47698915001	2"	10	353	17	250	170	518	5.2
CHF0133LM	47698916001	2"	13.3	471	17	250	170	518	5.24
CHF0167LM	47698917001	2"	16.7	589	17	250	170	518	5.26
CHF0200LM	47698918001	3"	20	706	17	250	205	600	9.31
CHF0260LM	47698919001	3"	26	918	17	250	205	700	10.69
CHF0305LM	47698920001	3"	30.5	1077	17	250	205	700	10.69
CHF0383LM	47698921001	3"	38.3	1354	17	250	205	930	13.7
CHF0450LM	47698922001	3"	45	1589	17	250	205	930	13.7

COMPRESSED AIR FILTERS



Technical Data - Compressed Air Filters CHF Series - Grade S

FILTER MODEL	PN	CONNECTION SIZE	FLOW RATE		MAX. PRESSURE		DIMENSIONS		WEIGHT [kg]
			[m³/min]	[cfm]	[bar]	[psi]	W [mm]	H [mm]	
CHF005LS	47698923001	3/8"	0.5	18	17	250	76	225	0.55
CHF007LS	47698924001	1/2"	0.7	24	17	250	76	225	0.55
CHF013LS	47698925001	3/4"	1.3	44	17	250	98	280	1.07
CHF018LS	47698926001	3/4"	1.8	65	17	250	98	280	1.09
CHF025LS	47698927001	1"	2.5	88	17	250	129	319	2.06
CHF032LS	47698928001	1"	3.2	112	17	250	129	319	2.06
CHF038LS	47698929001	1"	3.8	135	17	250	129	319	2.06
CHF067LS	47698930001	1 1/2"	6.7	235	17	250	129	409	2.36
CHF082LS	47698931001	1 1/2"	8.2	288	17	250	129	409	2.36
CHF100LS	47698932001	2"	10	353	17	250	170	518	5.2
CHF0133LS	47698933001	2"	13.3	471	17	250	170	518	5.24
CHF0167LS	47698934001	2"	16.7	589	17	250	170	518	5.26
CHF0200LS	47698935001	3"	20	706	17	250	205	600	9.31
CHF0260LS	47698936001	3"	26	918	17	250	205	700	10.69
CHF0305LS	47698937001	3"	30.5	1077	17	250	205	700	10.69
CHF0383LS	47698938001	3"	38.3	1354	17	250	205	930	13.7
CHF0450LS	47698939001	3"	45	1589	17	250	205	930	13.7

Technical Data - Compressed Air Filters CHF Series - Grade A

FILTER MODEL	PN	CONNECTION SIZE	FLOW RATE		MAX. PRESSURE		DIMENSIONS		WEIGHT [kg]
			[m³/min]	[cfm]	[bar]	[psi]	W [mm]	H [mm]	
CHF005LA	47698957001	3/8"	0.5	18	17	250	76	225	0.55
CHF007LA	47698958001	1/2"	0.7	24	17	250	76	225	0.55
CHF013LA	47698959001	3/4"	1.3	44	17	250	98	280	1.07
CHF018LA	47698960001	3/4"	1.8	65	17	250	98	280	1.09
CHF025LA	47698961001	1"	2.5	88	17	250	129	319	2.06
CHF032LA	47698962001	1"	3.2	112	17	250	129	319	2.06
CHF038LA	47698963001	1"	3.8	135	17	250	129	319	2.06
CHF067LA	47698964001	1 1/2"	6.7	235	17	250	129	409	2.36
CHF082LA	47698965001	1 1/2"	8.2	288	17	250	129	409	2.36
CHF100LA	47698966001	2"	10	353	17	250	170	518	5.2
CHF0133LA	47698967001	2"	13.3	471	17	250	170	518	5.24
CHF0167LA	47698968001	2"	16.7	589	17	250	170	518	5.26
CHF0200LA	47698969001	3"	20	706	17	250	205	600	9.31
CHF0260LA	47698970001	3"	26	918	17	250	205	700	10.69
CHF0305LA	47698971001	3"	30.5	1077	17	250	205	700	10.69
CHF0383LA	47698972001	3"	38.3	1354	17	250	205	930	13.7
CHF0450LA	47698973001	3"	45	1589	17	250	205	930	13.7



Technical Data - Compressed Air Filters CHF Series - Grade R

FILTER MODEL	PN	CONNECTION SIZE	FLOW RATE		MAX. PRESSURE		DIMENSIONS		WEIGHT [kg]
			[m³/min]	[cfm]	[bar]	[psi]	W [mm]	H [mm]	
CHF005LR	47698940001	3/8"	0.5	18	17	250	76	225	0.55
CHF007LR	47698941001	1/2"	0.7	24	17	250	76	225	0.55
CHF013LR	47698942001	3/4"	1.3	44	17	250	98	280	1.07
CHF018LR	47698943001	3/4"	1.8	65	17	250	98	280	1.09
CHF025LR	47698944001	1"	2.5	88	17	250	129	319	2.06
CHF032LR	47698945001	1"	3.2	112	17	250	129	319	2.06
CHF038LR	47698946001	1"	3.8	135	17	250	129	319	2.06
CHF067LR	47698947001	1 1/2"	6.7	235	17	250	129	409	2.36
CHF082LR	47698948001	1 1/2"	8.2	288	17	250	129	409	2.36
CHF100LR	47698949001	2"	10	353	17	250	170	518	5.2
CHF0133LR	47698950001	2"	13.3	471	17	250	170	518	5.24
CHF0167LR	47698951001	2"	16.7	589	17	250	170	518	5.26
CHF0200LR	47698952001	3"	20	706	17	250	205	600	9.31
CHF0260LR	47698953001	3"	26	918	17	250	205	700	10.69
CHF0305LR	47698954001	3"	30.5	1077	17	250	205	700	10.69
CHF0383LR	47698955001	3"	38.3	1354	17	250	205	930	13.7
CHF0450LR	47698956001	3"	45	1589	17	250	205	930	13.7

Grade M - General Purpose Protection

Particle removal down to 0.1 micron including coalesced liquid, water and oil, providing a maximum remaining oil aerosol content of 0.03 mg/m³ @ 21°C

Grade S - High Efficiency Oil Removal Filtration

Particle removal down to 0.01 micron including water and oil aerosols, providing a maximum remaining oil aerosol content of 0.01 mg/m³ @ 21°C

(Precede with Grade M filter)

Grade A - Activated Carbon Filtration

Oil vapor and hydrocarbon odor removal, providing a maximum remaining oil content of <0.003 mg/m³ (<0.003 ppm) @ 21°C (Precede with Grade S filter)

Grade R - General Purpose Dust Filtration

Dust particle removal down to 1 micron

Operating Limitations:

Max Operating Pressure 17.2 bar g
 Max Recommended Operating Temp 80°C (Grade M, S, R)

Max Recommended Operating Temp 50°C (Grade A)
 Min Recommended Operating Temp 1°C

LINE PRESSURE	bar g	1	2	3	5	7	9	11	13	15	17
CORRECTION FACTOR		0.38	0.53	0.65	0.85	1.00	1.13	1.25	1.36	1.46	1.56

To use correction factors, multiply the filter's capacity by the correction factor to get the new filter flow capacity at the non-standard operating pressure. For example, a 190 m³/h filter operating at 11 bar has a correction factor of 1.25. 1.25 x 190 = 237.5 m³/h capacity at 11 bar.

FILTER ELEMENTS



Technical Data - Compressed Air Filter Elements CHF Series - Grade M

FILTER MODEL	FILTER ELEMENT
CHF005LM	47699428001
CHF007LM	47699432001
CHF013LM	47699436001
CHF018LM	47699440001
CHF025LM	47699444001
CHF032LM	47699448001
CHF038LM	47699452001
CHF067LM	47699456001
CHF082LM	47699460001
CHF100LM	47699464001
CHF0133LM	47699468001
CHF0167LM	47699472001
CHF0200LM	47699476001
CHF0260LM	47700081001
CHF0305LM	47700085001
CHF0383LM	47700089001
CHF0450LM	47700093001

Technical Data - Compressed Air Filter Elements CHF Series - Grade A

FILTER MODEL	FILTER ELEMENT
CHF005LA	47699431001
CHF007LA	47699435001
CHF013LA	47699439001
CHF018LA	47699443001
CHF025LA	47699447001
CHF032LA	47699451001
CHF038LA	47699455001
CHF067LA	47699459001
CHF082LA	47699463001
CHF100LA	47699467001
CHF0133LA	47699471001
CHF0167LA	47699475001
CHF0200LA	47700080001
CHF0260LA	47700084001
CHF0305LA	47700088001
CHF0383LA	47700092001
CHF0450LA	47700096001

Technical Data - Compressed Air Filter Elements CHF Series - Grade S

FILTER MODEL	FILTER ELEMENT
CHF005LS	47699429001
CHF007LS	47699433001
CHF013LS	47699437001
CHF018LS	47699441001
CHF025LS	47699445001
CHF032LS	47699449001
CHF038LS	47699453001
CHF067LS	47699457001
CHF082LS	47699461001
CHF100LS	47699465001
CHF0133LS	47699469001
CHF0167LS	47699473001
CHF0200LS	47700078001
CHF0260LS	47700082001
CHF0305LS	47700086001
CHF0383LS	47700090001
CHF0450LS	47700094001

Technical Data - Compressed Air Filter Elements CHF Series - Grade R

FILTER MODEL	FILTER ELEMENT
CHF005LR	47699430001
CHF007LR	47699434001
CHF013LR	47699438001
CHF018LR	47699442001
CHF025LR	47699446001
CHF032LR	47699450001
CHF038LR	47699454001
CHF067LR	47699458001
CHF082LR	47699462001
CHF100LR	47699466001
CHF0133LR	47699470001
CHF0167LR	47699474001
CHF0200LR	47700079001
CHF0260LR	47700083001
CHF0305LR	47700087001
CHF0383LR	47700091001
CHF0450LR	47700095001

CHR SERIES REFRIGERATION AIR DRYERS

Applications

- Compressed air systems

At a glance...



Operating Pressure
16/14 bar g



Inlet air temperature
35 °C (55° max)



Ambient temperature
25 °C (45° max)

The advanced design and innovative technology offered by CHR Series refrigeration dryers provides an optimised performance alongside a more efficient mode of management.

The electronic controller, complete with user-friendly interface, has been simplified to focus on the essential functions of operation and regulation, including the unique fan control (CHR6 – CHR167).

Simplicity in design, unrivalled reliability, and extraordinary value for money are the core strengths of this new family of units.

Standard voltage

- CHR6 – CHR36: 230V/1ph/50-60Hz
- CHR47 – CHR167: 230V/1ph/50Hz
- CHR217 – CHR350: 400V/3ph/50Hz

Main design features

Variable speed fan

The only one in the market to offer a complete control of the dew point through the variable speed fan controlled by the microprocessor. Thanks to this solution we've eliminated the hot gas bypass valve and the fan pressure switch, critical components for the defects of this type of machines.

Multi-function control panel

It offers a wide range of parameters and alarms such as: high temperature, low temperature (antifreeze), probe failure, alarm history, etc.



Available options

- Non-standard voltages
CHR47 – CHR125 are available with 230V/1ph/60Hz
CHR217 is available with 460V/3ph/60Hz
- All models are available with NPT connections

New heat exchangers

Completely designed in our laboratories to guarantee the desired level of performances with the lowest pressure drop.

Energy saving and antifreeze mode

The compressor stops in case of low load and ambient temperature below 15 °C.

Compact and simple design

Sheet metal panels and internal components designed in order to reduce costs during assembly, maintaining the high quality guaranteed by Champion.



For higher capacities up to 45 m³/min (2,700 m³/h) please contact the Champion Sales Team

DRYER	PN	AIR FLOW		ABSORBED POWER [kW]	POWER SUPPLY [V/PH/HZ]	MAX PRESSURE [bar g]	AIR CONNECTIONS [BSP]	REFRIGERANT	DIMENSIONS		
		[m ³ /h]	[m ³ /min]						W [mm]	D [mm]	H [mm]
CHR6	47703069001	36	0.60	0.12	230/1/50-60	16	3/8"	R513A	305	360	408
CHR9	47703070001	54	0.90	0.17	230/1/50-60	16	1/2"	R513A	325	430	445
CHR12	47703071001	72	1.20	0.17	230/1/50-60	16	1/2"	R513A	325	430	445
CHR18	47703072001	108	1.80	0.29	230/1/50-60	16	1/2"	R513A	325	430	445
CHR24	47703073001	144	2.40	0.41	230/1/50-60	16	3/4"	R513A	395	486	565
CHR30	47703074001	180	3.00	0.47	230/1/50-60	16	3/4"	R513A	395	486	565
CHR36	47703075001	216	3.60	0.61	230/1/50-60	16	3/4"	R513A	395	486	565
CHR47	47703076001	280	4.67	0.6	230/1/50	16	1"	R407C	485	595	614
CHR57	47703077001	340	5.67	0.6	230/1/50	16	1"	R407C	485	595	614
CHR83	47703078001	500	8.33	0.9	230/1/50	16	1-1/2"	R407C	500	660	970
CHR102	47703079001	610	10.17	0.9	230/1/50	16	1-1/2"	R407C	500	660	970
CHR125	47703080001	750	12.50	1.23	230/1/50	14	2"	R407C	520	800	1195
CHR167	47703081001	1000	16.67	1.43	230/1/50	14	2-1/2"	R407C	520	835	1195
CHR217	47703082001	1300	21.67	2.14	400/3/50	14	2-1/2"	R407C	520	835	1230
CHR333	47703083001	2000	33.33	2.78	400/3/50	14	3"	R407C	806	1012	1539
CHR417	47703084001	2500	41.67	3.54	400/3/50	14	3"	R407C	806	1012	1539
CHR500	47716993001	3540	59.00	6.29	400/3/50	13	DN125	R407C	1500	1500	1555
CHR700	47716994001	4956	82.60	7.29	400/3/50	13	DN125	R407C	1500	1500	1555
CHR800	47716995001	5664	94.40	9.52	400/3/50	13	DN150	R407C	1500	1500	1555
CHR900	47716996001	6372	106.20	9.52	400/3/50	13	DN150	R407C	1500	1500	1555

Timer drain as standard, electronic no loss drain option on request on Models CHR6 - CHR217. Integrated zero loss drain as standard on Models CHR333 and CHR417.

CORRECTION FACTOR FOR WORKING PRESSURE

OPERATING PRESSURE [bar]	3	4	5	6	7	8	9	10	11	12	13	14	15	16
CORRECTION FACTOR FC1	0.70	0.78	0.85	0.93	1.00	1.06	1.11	1.15	1.18	1.20	1.22	1.24	1.25	1.26

CORRECTION FACTOR FOR INLET AIR TEMPERATURE CHANGES

TEMPERATURE [°C]	30	35	40	45	50	55
CORRECTION FACTOR FC2	1.20	1.00	0.85	0.71	0.58	0.49

CORRECTION FACTOR FOR AMBIENT TEMPERATURE CHANGES

TEMPERATURE [°C]	25	30	35	40	42	45
CORRECTION FACTOR FC3	1.00	0.96	0.92	0.88	0.85	0.80

Calculation for correct Dryer Air flow = Nominal Dryer Air Flow x FC1 x FC2 x FC3

MODULAR DESICCANT DRYERS

Applications

- Automotive
- Food and beverage
- Pharmaceutical
- Chemical
- Oil & Gas

At a glance...



Operating Pressure
14 bar



Flow Rate
0.08 - 5.00 m³/min



Pressure Dew Points
-40°C (-25°C / -70°C)

A-Series modular compressed air dryers - a dedicated solution for every application

By combining the proven benefits of desiccant drying with modern design, Champion provides an extremely compact and reliable system to dry and clean compressed air efficiently.

At the heart of any compressed air treatment solution is the dryer, its purpose, to remove water vapour, stop condensation, corrosion and in the case of adsorption dryers, inhibit the growth of micro-organisms.

The Champion A-Series of heatless regenerative desiccant dryers have proven to be the ideal solution for many thousands of compressed air users worldwide in a wide variety of industries.

Advantages at a glance:

- Robust and reliable industry-proven design
- Suitable for all industries and applications - some desiccant dryer regeneration methods prevent their use in certain industries/applications
- Lower capital investment and reduced complexity compared to other dryer regeneration methods
- Lower maintenance costs in comparison to other dryer regeneration methods
- No heat, heaters, or heat-related issues

High air quality, low cost of ownership

Features are your benefits

High Air Quality:

Delivers ISO Class 2 or Class 1 pressure dew point air for critical applications; high efficiency pre and post-filters provide constant high air quality, protecting downstream air from contamination.

Superior Reliability:

Proven electronic control performance indicators, extruded aluminium with anodisation and epoxy painting, and NEMA 3/IP54 Protection (also suitable for outdoor installation) make desiccant dryers durable and high-strength.



Total Cost of Investment:

Reduced cost of ownership with point of use design to treat only the required air, conservative pressure drop 0.2 Barg, and purge reduction on compressed air demand (on/off-load).

Ease of Use:

User-friendly electronic interface with alarm indicators available for models 40 and above.

Serviceability:

Modular dryers feature an optimised design for simplified maintenance and preventative maintenance alerts (models 40 and above).

Compact & Flexible Solution:

Space-saving design for optimised installation with air inlet and outlet in the back of unit and connection piping can come from right or left. Model up to 0.42 m³/min can be wall-mounted or installed horizontally

Performance Improvement:

Extended rated pressure range from 4 to 14 Barg and increased airflow range coverage up to 300 m³/h. Guaranteed class 2 (-40°C) and optionally class 1 (-70°C) pressure dew point.

Longer Cycle Life:

Modular dryers have a longer cycle time, 10 minutes, than most competitors (4 to 8 minutes maximum).

CHA1M -40°C to CHA50M -40°C Series

TYPE	PART NO	CAPACITY			MAX PRESSURE		PRESSURE DEW POINT	AIR IN/OUT CONNECTION	POWER SUPPLY	DIMENSIONS [MM]			WEIGHT	DESICCANT PER TOWER
		[m³/min]	[m³/h]	[SCFM]	[bar g]	[psig]	[°C]	[BSP (in)]	[V/Ph/Hz]	[W]	[D]	[H]	[kg]	[kg]
CHA1 -40°C	47700856001	0.08	5	3	14	203	-40	3/8"	230/1/50-60	238	212	423	11	0.7
CHA3 -40°C	47700857001	0.25	15	9	14	203	-40	3/8"	230/1/50-60	238	212	823	18	2.2
CHA4 -40°C	47700858001	0.42	25	15	14	203	-40	3/8"	230/1/50-60	238	212	1073	27	3.0
CHA7 -40°C	47700859001	0.67	40	24	14	203	-40	3/4"	230/1/50-60	475	405	968	44	6.4
CHA9 -40°C	47700860001	0.92	55	32	14	203	-40	3/4"	230/1/50-60	475	405	1118	50	8.4
CHA12 -40°C	47700861001	1.17	70	41	14	203	-40	3/4"	230/1/50-60	475	405	1318	60	10.9
CHA17 -40°C	47700862001	1.67	100	59	14	203	-40	1"	230/1/50-60	475	405	1673	73	15.4
CHA25 -40°C	47700863001	2.50	150	88	14	203	-40	1"	230/1/50-60	475	405	1873	90	18.0
CHA33 -40°C	47700864001	3.33	200	118	14	203	-40	1 1/2"	230/1/50-60	536	495	1705	177	30.8
CHA42 -40°C	47700865001	4.17	250	147	14	203	-40	1 1/2"	230/1/50-60	536	495	1905	180	35.9
CHA50 -40°C	47700866001	5.00	300	177	14	203	-40	1 1/2"	230/1/50-60	536	495	1905	188	35.9

CHA7 -40°C DS to CHA50M -40°C ES Series

TYPE	PART NO	CAPACITY			MAX PRESSURE		PRESSURE DEW POINT	AIR IN/OUT CONNECTION	POWER SUPPLY	DIMENSIONS [MM]			WEIGHT	DESICCANT PER TOWER
		[m³/min]	[m³/h]	[SCFM]	[bar g]	[psig]	[°C]	[BSP (in)]	[V/Ph/Hz]	[W]	[D]	[H]	[kg]	[kg]
CHA7 -40°C ES	47700867001	0.67	40	24	14	203	-40	3/4"	230/1/50-60	475	405	968	44	6.4
CHA9 -40°C ES	47700868001	0.92	55	32	14	203	-40	3/4"	230/1/50-60	475	405	1118	50	8.4
CHA12 -40°C ES	47700869001	1.17	70	41	14	203	-40	3/4"	230/1/50-60	475	405	1318	60	10.9
CHA17 -40°C ES	47700870001	1.67	100	59	14	203	-40	1"	230/1/50-60	475	405	1673	73	15.4
CHA25 -40°C ES	47700871001	2.50	150	88	14	203	-40	1"	230/1/50-60	475	405	1873	90	18.0
CHA33 -40°C ES	47700872001	3.33	200	118	14	203	-40	1 1/2"	230/1/50-60	536	495	1705	177	30.8
CHA42 -40°C ES	47700873001	4.17	250	147	14	203	-40	1 1/2"	230/1/50-60	536	495	1905	180	35.9
CHA50 -40°C ES	47700874001	5.00	300	177	14	203	-40	1 1/2"	230/1/50-60	536	495	1905	188	35.9

CHA7 -70°C to CHA50M -70°C Series

TYPE	PART NO	CAPACITY			MAX PRESSURE		PRESSURE DEW POINT	AIR IN/OUT CONNECTION	POWER SUPPLY	DIMENSIONS [MM]			WEIGHT	DESICCANT PER TOWER
		[m³/min]	[m³/h]	[SCFM]	[bar g]	[psig]	[°C]	[BSP (in)]	[V/Ph/Hz]	[W]	[D]	[H]	[kg]	[kg]
CHA7 -70°C	47700875001	0.53	32	19	14	203	-70	3/4"	230/1/50-60	475	405	968	44	6.4
CHA9 -70°C	47700876001	0.73	44	26	14	203	-70	3/4"	230/1/50-60	475	405	1118	50	8.4
CHA12 -70°C	47700877001	0.93	56	33	14	203	-70	3/4"	230/1/50-60	475	405	1318	60	10.9
CHA17 -70°C	47700878001	1.33	80	47	14	203	-70	1"	230/1/50-60	475	405	1673	73	15.4
CHA25 -70°C	47700879001	2.00	120	71	14	203	-70	1"	230/1/50-60	475	405	1873	90	18.0
CHA33 -70°C	47700880001	2.67	160	94	14	203	-70	1 1/2"	230/1/50-60	536	495	1705	177	30.8
CHA42 -70°C	47700881001	3.33	200	118	14	203	-70	1 1/2"	230/1/50-60	536	495	1905	180	35.9
CHA50 -70°C	47700882001	4.00	240	142	14	203	-70	1 1/2"	230/1/50-60	536	495	1905	188	35.9

CORRECTION FACTORS

		INLET AIR PRESSURE											
		bar g	4	5	6	7	8	9	10	11	12	13	14
INLET AIR TEMPERATURE	35°C	0.63	0.75	0.88	1.00	1.14	1.25	1.37	1.49	1.64	1.75	1.89	
	40°C	0.55	0.66	0.77	0.88	1.00	1.00	1.20	1.32	1.43	1.54	1.64	
	45°C	0.45	0.54	0.63	0.72	0.81	0.90	1.00	1.08	1.18	1.27	1.35	
	50°C	0.32	0.39	0.45	0.52	0.58	0.65	0.71	0.78	0.85	0.91	0.97	

		INLET AIR PRESSURE											
		psi g	58	73	87	102	116	131	145	160	174	189	203
INLET AIR TEMPERATURE	95°F	0.63	0.75	0.88	1.00	1.14	1.25	1.37	1.49	1.64	1.75	1.89	
	104°F	0.55	0.66	0.77	0.88	1.00	1.00	1.20	1.32	1.43	1.54	1.64	
	113°F	0.45	0.54	0.63	0.72	0.81	0.90	1.00	1.08	1.18	1.27	1.35	
	122°F	0.32	0.39	0.45	0.52	0.58	0.65	0.71	0.78	0.85	0.91	0.97	

Prefilters and Postfilter are supplied as standard on Modular Dryers.

Prefilter

Particle removal down to 0.01 micron

- Including water and oil aerosols
- Maximum remaining oil aerosol content of 0.01 mg/m³ @ 21°C

Postfilter

Particle removal down to 0.1 micron

- Including coalesced liquid, water and oil
- Maximum remaining oil aerosol content of 0.03 mg/m³ @ 21°C

TWIN TOWER HEATLESS DESICCANT DRYERS

At a glance...



Capacity
400 - 8500 m³/hr



Weight
285 - 4400 kg



Connection Size
1½ - 3"

Applications

- Air bearings
- Instrument Air
- Sand blasting
- Air gauging
- Spray painting
- Chemical Process - Oxidation, Ammonia Production
- Conveying, powder products
- Fluidics, sensors
- Food & beverages, direct air contact
- Micro-electronics manufacture
- Clean room processing air - blanketing
- Food & beverage - packaging, forming
- Photographic film processing



Premium in-house air treatment manufacturing

A modern production system and process demands increasing levels of air quality, and compressed air operators need to ensure that the downstream equipment also delivers on it 100%.

The new downstream portfolio manufactured by Champion utilising the latest technology provides an energy efficient solution at the lowest life cycle costs. The same quality, performance, and efficiency standards delivered by the compressors can now be enjoyed from the air treatment range.

Investment in our manufacturing site, in addition to the support teams, ensures that compressed air operators don't need to worry about the quality of their compressed air – quality that is key to ensuring maximum production efficiency and investment protection.

TYPE	PART NO	CONNECTION SIZE [inch]	CAPACITY		WEIGHT [kg]	DIMENSIONS		
			[m ³ /hr]	[m ³ /hr]		LENGTH	WIDTH	HEIGHT
CHT67F	47726991001	1 ½"	400	340	285	2160	825	530
CHT83F	47726992001	1 ½"	500	425	400	2380	796	550
CHT125F	47726993001	2"	750	637.5	520	2117	970	620
CHT150F	47726994001	2"	900	765	700	2305	970	620
CHT67FS	47727056001	1 ½"	400	340	285	2160	825	530
CHT83FS	47727057001	1 ½"	500	425	400	2380	796	550
CHT125FS	47727058001	2"	750	637.5	520	2117	970	620
CHT150FS	47727059001	2"	900	765	700	2305	970	620
CHT67F-70	47727069001	1 ½"	400	340	285	2160	825	530
CHT83F-70	47727070001	1 ½"	500	425	400	2380	796	550
CHT125F-70	47727071001	2"	750	637.5	520	2117	970	620
CHT150F-70	47727072001	2"	900	765	700	2305	970	620

CHT67F to CHT150F is standard at -40°C PDP, CHT67FS to CHT150FS is standard at -40°C PDP with Energy Management System, CHT67F-70 to CHT150F-70 is at -70°C PDP

CHM-DRY SERIES MEMBRANE DRYERS

At a glance...



Operating Pressure
12 bar



Flow Rate
0.05 - 3 m³/min



Pipe Size
¼ - 1"



Operating Temp. Range
1.5 - 60°C



Applications

- Automotive painting
- Industrial "Point-Of-Use" drying
- Low dew point instrument air
- Pneumatics
- Medical air
- Analytical Equipment
- Pressurising electrical cabinets

CHM-DRY membrane air dryers have been developed for high efficient removal of water vapours from compressed air.

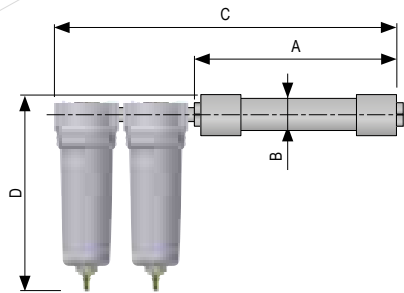

TYPE	PART NO	PIPE SIZE [inch]	OPERATING PRESSURE [bar]	FLOW RATE *		DIMENSIONS			
				[m ³ /min]	[cfm]	A [mm]	B [mm]	C [mm]	D [mm]
CHM-DRY 3	CC1189577	¼	12	0.05	1.8	224	43.7	325	175
CHM-DRY 6	CC1189578	¼	12	0.1	3.5	325	43.7	453	175
CHM-DRY 9	CC1189579	¼	12	0.15	5.3	427	43.7	555	175
CHM-DRY 12	CC1189580	¼	12	0.2	7.1	503	43.7	611	175
CHM-DRY 18	CC1189581	½	12	0.3	10.6	312	61	476	208
CHM-DRY 24	CC1189582	½	12	0.4	14.1	376	61	540	208
CHM-DRY 32	CC1189583	½	12	0.6	21.2	465	61	661	208
CHM-DRY 44	CC1189584	½	12	0.8	28.3	592	61	788	208
CHM-DRY 63	CC1189585	½	12	1.05	37.1	411	89	607	208
CHM-DRY 90	CC1189586	½	12	1.5	53	551	89	755	284
CHM-DRY 123	CC1189587	½	12	2.05	72.4	551	89	577	284
CHM-DRY 180	CC1189588	½	12	3	106.6	607	114	1,805	290

* At 7 bar, inlet dew point 35 °C, outlet dew point 15 °C.

Prices includes complete kit.

OPERATING PRESSURE - CORRECTION FACTORS - C									
OPERATING PRESSURE [bar]	4	5	6	7	8	9	10	11	12
OPERATING PRESSURE [psi]	58	72	87	100	115	130	145	160	174
CORRECTION FACTOR	0.41	0.56	0.76	1	1.22	1.48	1.76	1.86	2.22

AIRCOOLED AFTERCOOLERS

CHRA SERIES AIR COOLED AFTERCOOLERS

At a glance...



Operating Pressure
1 - 16 bar



Flow Rate
1.1 - 75 m³/min



Operating Temp. Range
25 - 120°C



Pipe Size
1 - 2½"

Air cooled aftercoolers series CHRA have been designed to reduce compressed air temperature and water vapour dew point in compressed air system. A high efficiency axial fan forces ambient air over the heat exchangers copper tubes supported by aluminium fins, which provides the necessary cooling effect. The compressed air is cooled down to approximately 10°C above ambient temperature. CHRA aftercoolers ensures the maximum performance and protection of all equipment, such as refrigeration dryers, adsorption dryers and filters, positioned downstream of this unit.



TYPE	PART NO	FLOW RATE		AIR		FAN [W]	OPERATING PRESSURE [bar]	DIMENSIONS [mm]		WEIGHT [kg]
		[m ³ /min]	[m ³ /h]	[IN]	[OUT]			LENGTH	HEIGHT	
RA10	TBARA10	1	60	1"	1"	20	1 - 16	600	955	19
RA20	TBARA20	2	120	1"	1"	20	1 - 16	600	955	20
RA30	TBARA30	3	180	1 1/2"	1 1/2"	115	1 - 16	820	1145	29
RA40	TBARA40	4	240	1 1/2"	1 1/2"	135	1 - 16	1030	1145	32
RA65	TBARA65	6.5	390	2"	1 1/2"	690	1 - 16	970	1365	51
RA80	TBARA80	8	480	2"	1 1/2"	690	1 - 16	965	1405	53
RA120	TBARA120	12	720	2"	2"	760	1 - 16	1000	1555	97
RA160	TBARA160	16	960	2 1/2"	2 1/2"	760	1 - 16	1205	1765	120
RA200	TBARA200	20	1200	3"	2 1/2"	660	1 - 16	1410	2120	240
RA250	TBARA250	25	1500	3"	3"	660	1 - 16	1410	2120	250
RA300	TBARA300	30	1800	DN100	DN100	660	1 - 16	2095	2060	280
RA400	TBARA400	40	2400	DN100	DN100	2 x 760	1 - 16	2415	2050	300
RA500	TBARA500	50	3000	DN125	DN125	2 x 1300	1 - 12	3245	2000	310
RA650	TBARA650	65	3900	DN125	DN125	2 x 1300	1 - 12	3245	2000	390
RA700	TBARA700	75	4500	DN150	DN150	2 x 1300	1 - 12	3325	2150	390

CHA SERIES

WATER COOLED AFTERCOOLERS

At a glance...



Operating Pressure
1 - 12 bar



Flow Rate
2.2 - 759.5 m³/min



Operating Temp. Range
1.5 - 200°C

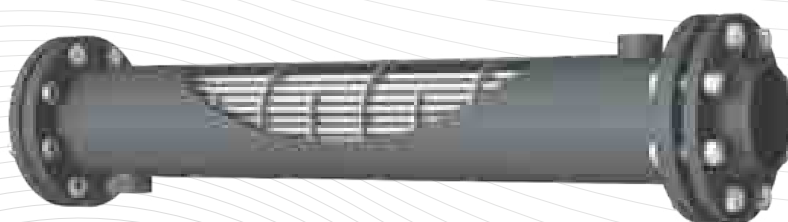

Applications

- Automotive
- Electronics
- Food & Beverage
- Chemical
- Petrochemical
- Plastics
- Paint
- General industrial application

Water-cooled aftercoolers series CHA have been designed, to reduce compressed air temperature thus water vapour content in compressed air system. Hot compressed air/gas passes through the tubes. Cooling water passes around the tubes in counter flow. CHA aftercooler ensures the maximum performance and protection of all equipment, such as refrigeration dryers, adsorption dryers and filters, positioned downstream of this unit.

TYPE	PART NO	AIR		OPERATING PRESSURE [bar]	FLOW RATE		DIMENSIONS	
		[IN]	[OUT]		[m ³ /min]	[cfm]	A [mm]	B [mm]
A30	TBAA30	1 1/2"	1 1/2"	1 - 12	3	106	850	385
A60	TBAA60	2 1/2"	1 1/2"	1 - 12	6	212	1060	385
A80	TBAA80	2 1/2"	1 1/2"	1 - 12	8	282	1300	385
A140	TBAA140	DN100	DN100	1 - 12	14	494	1300	702
A250	TBAA250	DN100	DN100	1 - 12	25	882	1300	702
A400	TBAA400	DN150	DN125	1 - 12	40	1412	1300	702
A500	TBAA500	DN175	DN125	1 - 12	50	1765	1300	770
A800	TBAA800	DN250	DN150	1 - 12	80	2824	1300	845
A1100	TBAA1100	DN250	DN150	1 - 12	110	3882	1300	845
A1500	TBAA1500	DN300	DN200	1 - 12	150	5294	1300	925
A1800	TBAA1800	DN350	DN200	1 - 12	180	6353	1300	925
A2100	TBAA2100	DN400	DN200	1 - 12	210	7412	1500	925

ACTIVATED CARBON TOWER CH-FT SERIES

At a glance...



Operating Pressure
13 - 15 barg



Flow Rate
0.5 - 95 m³/min



Operating Temp. Range
2 - 50 °C



Pipe Size
3/8" to 3"
Flange DN100 and DN150

Applications

- Automotive
- Electronics
- Food and beverage
- Chemical
- Petrochemical
- Plastics
- Paint
- General industrial application

The activated carbon tower eliminates oil vapour and hydrocarbon odours from your operations. Available in two configurations: – aluminum extrusion and fabricated tank are easy to maintain. In critical applications like food and pharmaceutical production where oil content ISO8573-1 Class 1 air or better is crucial, this carbon adsorption technology helps achieve the highest quality “technically oil-free air”.

Extruded aluminum units are up to model CHFT58L and are lightweight (CHFT5L can be wall-mounted). As per the tank configuration, they can be used in compressed air systems or at the point of use. Rightsizing units with corrective factors ensures consistent outlet air quality over 12 months of continuous operations.

This activated carbon tower is a cost-effective, adaptable solution to your oil-free compressed air requirements from the experts at Champion. Deliver Class 0 Air when installed with upstream and downstream filters to intercept activated carbon dust.

- Virtually Oil Free Air: ISO8573-1 Class 0: 0.003 mg/m³ oil content when used with inline filters
- Can be used with Oil Free and Contact Cooled Compressors
- Easy to replace lose high quality Activated Carbon Molecular Sieve
- Long service interval - media replacement every 12 months





CH-FT ACTIVATED CARBON TOWER

MODEL	CODE	GAS	BAR	M ³ /MIN	CFM	A	B	C	KG
CHFT5L	47745977001	1/2"	14	0.5	17.66	749	212	143	8
CHFT12L	47745978001	3/4"	14	1.25	44.14	890	267	255	20
CHFT18L	47745979001	1"	14	1.83	64.63	1090	267	255	24
CHFT25L	47745980001	1"	14	2.5	88.29	1440	267	255	32
CHFT30L	47745981001	1"	14	3	105.94	1640	267	255	35
CHFT58L	47745982001	1 1/2"	14	5.83	205.88	1660	447	255	70
CHFT100L	47745983001	2"	15	10	353.15	2113	391	N/A	115
CHFT166L	47745984001	2"	15	16.67	588.70	2148	436	N/A	245
CHFT260L	47745985001	3"	15	26	918.18	2463	483	N/A	222
CHFT383L	47745986001	3"	15	38.33	1353.61	2693	595	N/A	379
CHFT466L	47745987001	DN100	13	46.67	1648.14	2879	721	N/A	456
CHFT950L	47745988001	DN150	13	95	3354.90	3455	855	N/A	900

CH-FT ACTIVATED CARBON TOWER SERVICE KITS

MODEL	CODE
Kit CHFT5L Champion	47752199001
Kit CHFT12L Champion	47752200001
Kit CHFT18L Champion	47752201001
Kit CHFT25L Champion	47752202001
Kit CHFT30L Champion	47752203001
Kit CHFT58L Champion	47752204001
Kit CHFT100L Champion	47752205001
Kit CHFT166L Champion	47752206001
Kit CHFT260L Champion	47752207001
Kit CHFT383L Champion	47752208001
Kit CHFT466L Champion	47752209001
Kit CHFT950L Champion	47752210001

CORRECTION FACTORS

°C/BARG	4	5	6	7	8	9	10	11	12	13	14	15
25°C	0.63	0.75	0.88	1.00	1.00	1.00	1.00	1.14	1.14	1.14	1.25	1.25
30°C	0.63	0.75	0.88	1.00	1.00	1.00	1.00	1.14	1.14	1.14	1.25	1.25
35°C	0.63	0.75	0.88	1.00	1.00	1.00	1.00	1.14	1.14	1.14	1.25	1.25
40°C	0.63	0.66	0.77	0.88	0.88	0.88	0.88	1	1	1	1.11	1.11
45°C	0.63	0.54	0.63	0.72	0.72	0.72	0.72	0.81	0.81	0.81	0.9	0.9
50°C	0.63	0.39	0.45	0.52	0.52	0.52	0.52	0.58	0.58	0.58	0.65	0.65

CH-PP SERIES PAINTING AIR FILTRATION

At a glance...



Operating Pressure
16 bar



Flow Rate
0.1 - 108.33 m³/min



Operating Temp. Range
1.5 - 65°C



Pipe Size
1/2"

Applications

- Chemical
- Petrochemical
- Paint
- General industrial applications
- Breathing air

CH-PP pro paint system is specifically designed for purifying compressed air from solid, liquid and partially gaseous components. Protecting air equipment in addition to providing clean air for worker health protection. PP pro paint system is easy for wall mount.

Available modular combinations:

1. Comp. air for lower quality demands (down to 15 µm)
2. Comp. air for basic quality demands (down to 0,1 µm)
3. Comp. air for high quality demands (down to 0,01 µm)
4. Technical absolutely clean air (down to 0,1 µm, activated carbon)
5. Technical and breathable air
6. Compressed air for highest demands (all in one unit)

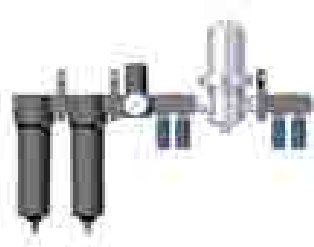



TYPE	PART NO	PIPE SIZE [inch]	FLOW RATE AT 7 BAR(G), 20 °C		DIMENSIONS			SEPARATOR CKL-PP	MICROFILTER M 0,1MM	MICROFILTER S 0,01MM	ACTIVE CARBON A	STERILE FILTER WITH ACTIVE CARBON SFA	ADSORPTION DRYER A-DRY 105	PRESSURE REGULATOR	QUICK COUPLING NO.
			[m³/min]	[cfm]	A [mm]	B [mm]	C [mm]								
CH-PP-107	CC1189591	1/2"	1.3	46	270	135	276	✓						✓	2
CH-PP-110	CC1189592	1/2"	2	71	270	135	345	✓						✓	2
CH-PP-207	CC1189593	1/2"	1.3	46	380	135	276	✓	✓					✓	2
CH-PP-210	CC1189594	1/2"	2	71	380	135	345	✓	✓					✓	2
CH-PP-307	CC1189595	1/2"	1.3	46	490	135	276	✓	✓	✓				✓	2
CH-PP-310	CC1189596	1/2"	2	71	490	135	345	✓	✓	✓				✓	2
CH-PP-407	CC1189597	1/2"	1.3	46	580	135	276		✓	✓	✓			✓	4
CH-PP-410	CC1189598	1/2"	2	71	580	135	345		✓	✓	✓			✓	4
CH-PP-507	CC1189599	1/2"	1.3	46	612	135	370		✓	✓		✓		✓	4
CH-PP-510	CC1189600	1/2"	2	71	612	135	440		✓	✓		✓		✓	4
CH-PP-607	CC1189601	1/2"	1.3	46	1150	335	917		✓	✓		✓	✓	✓	4
CH-PP-610	CC1189602	1/2"	2	71	1150	335	917		✓	✓		✓	✓	✓	4

CORRECTION FACTORS

OPERATING PRESSURE [bar]	2	3	4	5	6	7	8	9	10	11	12	13	14	15	16
OPERATING PRESSURE [psi]	29	44	58	72	87	100	115	130	145	160	174	189	203	218	232
CORRECTION FACTOR	0.38	0.50	0.63	0.75	0.88	1	1.13	1.25	1.38	1.50	1.63	1.75	1.88	2.00	2.13

0.1 MICRON MICROFILTER	FILTER ELEMENT TYPE	PART NO
	Filter Cartridge F007M	223182
	Filter Cartridge F010M	223183

0.1 MICRON FINEFILTER	FILTER ELEMENT TYPE	PART NO
	Filter Cartridge F007S	223192
	Filter Cartridge F010S	223193

0.1 MICRON A ACTIVATED CARBON	FILTER ELEMENT TYPE	PART NO
	Filter Cartridge F007A	223212
	Filter Cartridge F010A	223213

CKL-PP SEPARATOR	FILTER ELEMENT TYPE	PART NO
	Filter Cartridge F007-CKL-PP	CC1189457
	Filter Cartridge F010-CKL-PP	CC1189458

CHB-AIR BREATHING AIR FILTER

At a glance...



Operating Pressure
16 bar



Flow Rate
1.3 - 13 m³/min



Operating Temp. Range
1.5 - 45°C



Pipe Size
½ - 1½"



Applications

- Breathing air

CHB-AIR point of use filter set has been specifically developed for high efficient preparation of top quality breathing air. On request CHB-AIR filter set can be supplied with wall mounting brackets, pressure regulator and quick couplings.

WARNING!

Breathing air filter set CHB-AIR is not declared as CO₂ and CO removal filter. Despite that CHB-AIR comprises filter element which can reduce CO content.

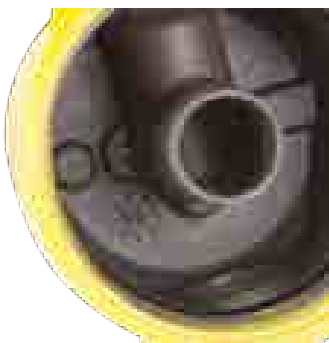

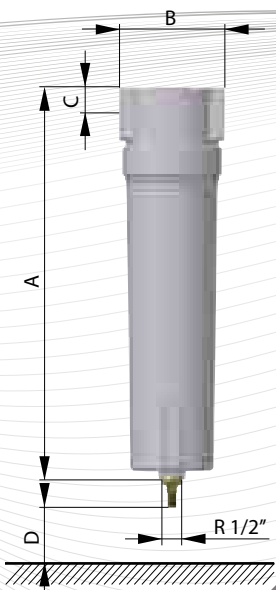

TYPE	PART NO	PIPE SIZE	FLOW RATE AT 7 BAR(G), 20 °C		DIMENSIONS				WEIGHT	FILTER ELEMENT TYPE
			[inch]	[m ³ /min]	[cfm]	A [mm]	B [mm]	C [mm]		
CHB-AIR 76	CC1189704	1/2"	1.3	46	187	88	20	60	1.41	F007 M/H2/A2
CHB-AIR 106	CC1189705	3/4"	2	70	257	88	20	80	1.8	F010 M/H2/A2
CHB-AIR 186	CC1189706	1"	3.3	116	263	125	32	100	4.71	F018 M/H2/A2
CHB-AIR 306	CC1189707	1"	5.58	197	363	125	32	120	6.6	F030 M/H2/A2
CHB-AIR 476	CC1189708	1 1/2"	8.5	300	461	125	32	140	8.4	F047 M/H2/A2
CHB-AIR 706	CC1189709	1 1/2"	13	459	640	125	32	160	11.7	F070 M/H2/A2

CORRECTION FACTORS

OPERATING PRESSURE [bar]	2	3	4	5	6	7	8	9	10	11	12	13	14	15	16
OPERATING PRESSURE [psi]	29	44	58	72	87	100	115	130	145	160	174	189	203	218	232
CORRECTION FACTOR	0.38	0.50	0.63	0.75	0.88	1	1.13	1.25	1.38	1.50	1.63	1.75	1.88	2.00	2.13

Prices are for complete set.

- Set includes 3 filter housings, 3 filter elements, 2 AOK16B condensate drains, 1 MCD drain and 1 PDI 16 differential pressure indicator.

FM	FILTER ELEMENT TYPE	PART NO
	Filter Cartridge F007M	223182
	Filter Cartridge F010M	223183
	Filter Cartridge F018M	223184
	Filter Cartridge F030M	223185
	Filter Cartridge F047M	223186
	Filter Cartridge F070M	223187

FH ²	FILTER ELEMENT TYPE	PART NO
	Filter Cartridge F007H2	CC1189441
	Filter Cartridge F010H2	CC1189442
	Filter Cartridge F018H2	CC1189443
	Filter Cartridge F030H2	CC1189454
	Filter Cartridge F047H2	CC1189455
	Filter Cartridge F070H2	CC1189456

FA ²	FILTER ELEMENT TYPE	PART NO
	Filter Cartridge F007A2	CC1189354
	Filter Cartridge F010A2	CC1189434
	Filter Cartridge F018A2	CC1189435
	Filter Cartridge F030A2	CC1189437
	Filter Cartridge F047A2	CC1189438
	Filter Cartridge F070A2	CC1189439

CHB-AIR PLUS BREATHING AIR FILTER

At a glance...



Operating Pressure
16 bar



Flow Rate
1.3 - 13 m³/min



Operating Temp. Range
1.5 - 45°C



Pipe Size
1/2"

Applications

- Breathing air

CHB-AIR PLUS system has been specifically designed for applications where high quality breathing air and monitoring of breathing air supply are needed. CHB-AIR PLUS is a combination of our CHB-AIR PLUS 0106 breathing air filter set combined with gas concentration analysers, fitted with pressure regulator and quick couplings, all packed in a compact and robust casing.

Gas concentration analysers constantly monitor CO, CO₂ and O₂ concentrations and trigger an alarm if concentrations exceed the EN12021 and BS4275:1997 standard compliant values. In this way CHB-AIR PLUS can safely provide high quality breathing air for up to 5 people.

Small dimensions and low weight enable the use of CHB-AIR PLUS in many applications as it can be transported and set up with ease.

Advantages

- High quality breathing air for up to 5 people
- Air quality monitoring (EN 12021, BS 4275:1997)
- Compact & light weight



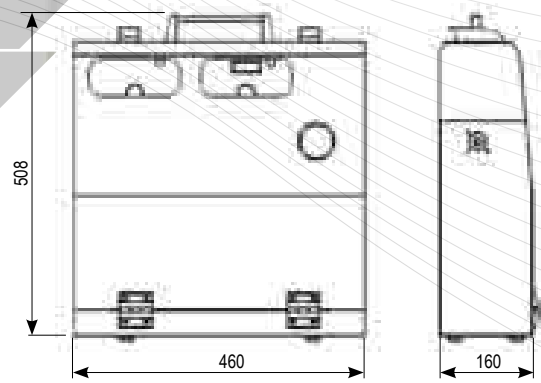

TYPE	PART NO	PIPE SIZE	FLOW RATE AT 7 BAR(G), 20 °C			DIMENSIONS			WEIGHT	FILTER ELEMENT TYPE
			[inch]	[m³/min]	[cfm]	A [mm]	B [mm]	C [mm]		
CHB-AIR PLUS	CC1189710	1/2"	2	71	508	460	160	12		

CORRECTION FACTORS															
OPERATING PRESSURE [bar]	2	3	4	5	6	7	8	9	10	11	12	13	14	15	16
OPERATING PRESSURE [psi]	29	44	58	72	87	100	115	130	145	160	174	189	203	218	232
CORRECTION FACTOR	0.38	0.50	0.63	0.75	0.88	1	1.13	1.25	1.38	1.50	1.63	1.75	1.88	2.00	2.13

Prices are for complete set.

FM	FILTER ELEMENT TYPE	PART NO
	Filter Cartridge F007M	223182

FH²	FILTER ELEMENT TYPE	PART NO
	Filter Cartridge F007H2	CC1189441

FA²	FILTER ELEMENT TYPE	PART NO
	Filter Cartridge F007A2	CC1189354

CH-AIRWATT SERIES HEAT RECOVERY UNITS

At a glance...



Operating Pressure
1 - 16 bar



Flow Rate
1.3 - 13 m³/min



Operating Temp. Range
5 - 120°C



Ambient Air Temp. Range
5 - 45°C

Applications

- Heat recovery in oil lubricated rotary screw compressors

External heat recovery unit - CH-AIRWATT is designed to efficiently exploit the waste heat, generated during compression of air in rotary screw compressors.

Sometimes this represents more than 70% of energy consumed by the rotary screw compressor for the operation. This heat can then be used to heat domestic water or for heating, at almost no additional costs. This does not only help save money, but is also environmentally friendly. Unit has two separate piping systems with counter flow. Energy exchange from compressor to sanitary water occurs in plate heat exchanger, where compressor oil and sanitary water meets. Unit is controlled by thermostatic valve, which prevents compressor system getting to cold and damaging compressor.

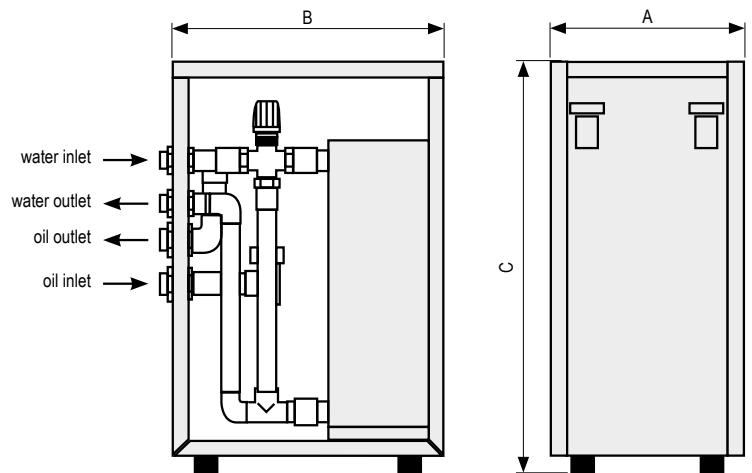

OPERATING PRESSURE (OIL)	1 - 16 bar
MAXIMUM WATER PRESSURE	10 bar
OPERATING TEMPERATURE	5°C - 120°C
MAX. OUTLET WATER TEMPERATURE	70°C
PRESSURE DROP (OIL)	~ 100 mbar
AMBIENT TEMPERATURE	5°C - 45°C
WATER TEMPERATURE INDICATOR	Analogue mechanical

TYPE	PART NO	MOTOR POWER [kW]	HEAT CAPACITY [kW]	OIL CONNECTION [G]	WATER CONNECTION [G]	DIMENSIONS			WEIGHT [kg]
						A [mm]	B [mm]	C [mm]	
CH-AIRWATT 22	CC1189573	15 - 22	12 - 17.6	1 1/4"	1"	360	500	760	33
CH-AIRWATT 37	CC1189574	26 - 37	20.8 - 29.6	1 1/4"	1"	360	500	760	35
CH-AIRWATT 75	CC1189575	45 - 75	36 - 60	1 1/4"	1"	360	500	760	42
CH-AIRWATT 100	CC1189576	90 - 132	72 - 100	2"	2"	450	600	860	58

VERTICAL AIR RECEIVERS

At a glance...



Operating Pressure
11 - 16 bar



Capacity
100 - 10000l

Air receivers are an important part of the compressed air system, evening out peaks and troughs in air demand, minimising pulsations from piston compressors and protecting your air compressor from over frequent load/unload or start stop cycles.

VERTICAL TANKS ¹⁾	CODE	DIRECTIVE	SIZE	PRESSURE	AIR OUTLET
			[litre]	[bar]	[inch]
TANK 100L-11	CC1214969K	2014/29/EU	100	11	3/4
TANK 150L-11	CC1214973K	2014/29/EU	150	11	1
TANK 200L-11	CC1215044K	2014/29/EU	200	11	1
TANK 200L-11	CC1215045K	2014/29/EU	200	11	2
TANK 270L-11	220662K	2014/29/EU	270	11	1
TANK 270L-11	CC1215046K	2014/29/EU	270	11	2
TANK 500L-11	220663K	2014/29/EU	500	11	1
TANK 500L-11	CC1215047K	2014/29/EU	500	11	2
TANK 720L-11	CC1229498K	2014/29/EU	720	11	2
TANK 900L-11	CC1120428K	2014/29/EU	900	11	1.5
TANK 900L-11	CC1215049K	2014/29/EU	900	11	2
TANK 1000L-12	220664K	2014/68/UE (PED)	1000	12	2
TANK 1500L-12	CC1120429K	2014/68/UE (PED)	1500	12	2
TANK 2000L-12	220665CK	2014/68/UE (PED)	2000	12	2
TANK 2000L-12	CC1215050K	2014/68/UE (PED)	2000	12	3
TANK 3000L-12	220668CK	2014/68/UE (PED)	3000	12	2
TANK 3000L-12	CC1215051K	2014/68/UE (PED)	3000	12	3
TANK 100L-16	CC1215052K	2014/29/EU	100	16	3/4
TANK 150L-16	CC1215055K	2014/29/EU	150	16	1
TANK 200L-15	CC1215056K	2014/29/EU	200	15	1
TANK 270L-16	CC1215057K	2014/29/EU	270	16	1
TANK 500L-16	CC1215058K	2014/29/EU	500	16	1
TANK 1000L-16	CC1215059K	2014/68/UE (PED)	1000	16	2
TANK 1500L-16	CC1215060K	2014/68/UE (PED)	1500	16	2
TANK 2000L-16	CC1109207K	2014/68/UE (PED)	2000	16	2
TANK 3000L-16	CC1215061K	2014/68/UE (PED)	3000	16	2
TANK 5000L-8	CC1215062K	2014/68/UE (PED)	5000	8	3
TANK 8000L-8	CC1215063K	2014/68/UE (PED)	8000	8	3
TANK 10000L-8	CC1215064K	2014/68/UE (PED)	10000	8	3
TANK 5000L-12	CC1215065K	2014/68/UE (PED)	5000	12	3
TANK 8000L-12	CC1215066K	2014/68/UE (PED)	8000	12	3
TANK 10000L-12	CC1215067K	2014/68/UE (PED)	10000	12	3

¹⁾ Including paint, support legs, pressure gauge, safety valve and inlet and outlet nozzles.

GALVANISED VERTICAL AIR RECEIVERS

At a glance...



Operating Pressure

11 - 16 bar



Capacity

100 - 3000l

Air receivers are an important part of the compressed air system, evening out peaks and troughs in air demand, minimising pulsations from piston compressors and protecting your air compressor from over frequent load/unload or start stop cycles.

VERTICAL TANKS ¹⁾	CODE	DIRECTIVE	SIZE [litre]	PRESSURE [bar]	AIR OUTLET [inch]
TANK 100L-11	CC1215039K	2014/29/EU	100	11	3/4
TANK 150L-11	CC1215040K	2014/29/EU	150	11	1
TANK 200L-11	CC1215041K	2014/29/EU	200	11	1
TANK 270L-11	CC1215042K	2014/29/EU	270	11	1
TANK 500L-11	CC1080281K	2014/29/EU	500	11	2
TANK 720L-11	CC1215043K	2014/29/EU	720	11	2
TANK 900L-11	CC1215094K	2014/29/EU	900	11	1 1/2
TANK 900L-11	CC1215095K	2014/29/EU	900	11	2
TANK 1000L-12	CC1103058K	2014/68/UE (PED)	1000	12	2
TANK 1500L-12	CC1215096K	2014/68/UE (PED)	1500	12	2
TANK 2000L-12	CC1103060K	2014/68/UE (PED)	2000	12	2
TANK 2000L-12	CC1215097K	2014/68/UE (PED)	2000	12	3
TANK 3000L-12	CC1215098K	2014/68/UE (PED)	3000	12	2
TANK 3000L-12	CC1215099K	2014/68/UE (PED)	3000	12	3
TANK 100L-16	CC1215100K	2014/29/EU	100	16	3/4
TANK 150L-16	CC1215101K	2014/29/EU	150	16	1
TANK 200L-15	CC1215102K	2014/29/EU	200	15	1
TANK 270L-16	CC1215103K	2014/29/EU	270	16	1
TANK 500L-16	CC1190548K	2014/29/EU	500	16	1
TANK 1000L-16	CC1190550K	2014/68/UE (PED)	1000	16	2
TANK 1500L-16	CC1215104K	2014/68/UE (PED)	1500	16	2
TANK 2000L-16	CC1215105K	2014/68/UE (PED)	2000	16	2
TANK 3000L-16	CC1215106K	2014/68/UE (PED)	3000	16	2

¹⁾ Including paint, support legs, pressure gauge, safety valve and inlet and outlet nozzles.

CONDENSATE DRAINS

At a glance...



Operating Pressure
0-80 bar



Environmental Protection
IP54, IP65



Champion drains can be applied in both oil-lubricated and oil-free compressor applications. Champion products carry globally recognised approvals, and each product is 100% tested before dispatch.

Champion drains are robust and designed for long life industrial applications.

The Champion direct-acting valve construction with a large orifice has proven to be the most reliable option for condensate draining applications, avoiding potential blockages. In addition, we apply stainless steel moving parts that offer an extended life guarantee and are less sensitive to aggressive particles found in the condensate.

Champion valves are constructed from robust brass or stainless steel, ensuring no damage occurs during transportation, installation, functional operation and subsequent maintenance throughout the drain's working life.

Drains are also installed outdoors. IP65 (NEMA4) insulation protection is, therefore, a minimum requirement. High-grade coil insulation protects the copper wire from overheating, and top brand PCB components are applied to our electronic modules.

Servicing Champion drains is quick and easy. Their service-friendly design ensures short maintenance intervals.

Based on their high and low-temperature operation characteristics, FPM seals have been specifically selected and used in all Champion CHTDC, CHTDV and CHCNL drains. In addition, FPM seals are chosen as this material has proven to be the best choice for compressed air condensate draining applications.

CHTDV & CHTDC ELECTRONIC TIMER-CONTROLLER CONDENSATE DRAINS

TECHNICAL DATA	CHTDV 230V 1/4"	CHTDV 115V 1/4"	CHTDV 230V 1/2"	CHTDV 115V 1/2"	CHTDV 230V 3/8"	CHTDV 115V 3/8"	CHTDC 230V 16bar 1/2"	CHTDC 115V 16bar 1/2"
SUPPLY VOLTAGE	230V	115V	230V	115V	230V	115V \dot{a}	230V	115V
OPERATING TEMP. RANGE	1 - 55°C (34 - 131°F)							
OPERATING PRESSURE	0 - 16 bar (0 - 232 psi)							
PROTECTION CLASS	IP65 (NEMA4)							
COIL POWER	10 W	13 W	10 W	13 W	10 W	13 W	10 W	13 W
MASS	0.4 kg						0.6 kg	
TIME ON	0.5 - 10 s							
TIME OFF	0.5 - 45 m							
INLET CONNECTION	1/4"		1/2"		3/8"		1/4" & 1/2"	
OUTLET CONNECTION	1/4"		1/2"		3/8"		1/2"	
FLOW RATE KVS	7 m ³ /h							
DIMENSIONS LXBXH(MM)	50x89x114 mm						94x89x127 mm	
MEDIUM	Condensate (air, water & oil)							
INTEGRAL STRAINER	No						Yes	
INTEGRAL BALL VALVE	No						Yes	
PART NUMBER	47803936001	47803935001	47774991001	47774993001	47774990001	47774992001	47775260001	47775262001



CHCNL 10 & 100 ELECTRONIC ZERO AIR LOSS DRAIN WITH ALARM

TECHNICAL DATA	CHCNL10 230V	CHCNL10 115V	CHCNL10 230V ALARM	CHCNL10 115V ALARM	CHCNL100 230V	CHCNL100 115V
SUPPLY VOLTAGE	230V	115V	230V	115V	230V	115V
FREQUENCY	50-60 Hz					
OPERATING PRESSURE	16bar (232psi)					
DRAIN CAPACITY (@16BAR/232 PSI)	45 l/h				665 l/h	
OPERATING TEMP. RANGE	1 - 50 °C (34 - 122 °F)					
INLET CONNECTION	1/2"					
OUTLET CONNECTION	1/4"					
ALARM FUNCTION	No		Yes N/O			
INLET STRAINER	Yes					
PROTECTION CLASS	IP65 (NEMA4)					
MASS	0.5 kg				1.5 kg	
DIMENSIONS (LXBXH)	123x74x92 mm				179x114x87 mm	
PART NUMBER	47775257001	47775258001	47775263001	47775264001	47775259001	47775261001

CONDENSATE DRAINS

IED SERIES ELECTRONIC CONDENSATE DRAINS



TECHNICAL DATA	IED	
VOLTAGE	230 VAC	115 VAC
FREQUENCY	50-60 Hz	50-60 Hz
INTERNAL FUSE	5 x 20 1A T	
POWER	10 VA	
OPERATING PRESSURE RANGE	0-16 bar [0-232 psi]	
DRAIN CAPACITY [AT 7 bar/101 PSI]	8 l/h at 7 bar [0,005 cfm at 101 psi]	
OPERATING TEMPERATURE RANGE	1.5-65 °C [35-149°F]	
INLET CONNECTION	G 1/2" parallel thread	
PROTECTION CLASS	IP54	
MASS [kg]	0.3	
OPERATING TEMPERATURE RANGE	1.5 to 65°C	
DIMENSIONS [L x B x H]	61 x 60 x 161 mm	
SERVICE NETWORK CONNECTION	-	-
ALARM OUTPUT	-	-
PART NUMBER	CC1182025	

EMD SERIES ELECTRONIC CONDENSATE DRAINS



TECHNICAL DATA	EMD12 230 V
SERVICE NETWORK CONNECTION	-
ALARM OUTPUT	-
VOLTAGE	230 VAC, 50-60 Hz
INTERNAL FUSE	5 x 20 1A T
POWER	10 VA
OPERATING PRESS. RANGE	0-16 bar [0-232 psi]
DRAIN CAPACITY [AT 7 bar/101 PSI]	12 l/h [0.007cfm]
OPERATING TEMP. RANGE	1.5-65°C [35-149°F]
INLET CONNECTION	G 1/2"
OUTLET CONNECTION	Push connection for tube ø8
PROTECTION CLASS	IP54
MASS [kg]	0.55
DIMENSIONS A x B x C [mm]	133 x 76 x 147
PART NUMBER	CC1112242

SAC 120 AUTOMATED CONDENSATE DRAINS



TECHNICAL DATA	
OPERATING TEMP. RANGE	1.5 - 65 °C [35-149 °F]
OPERATING PRESSURE	20 bar [290 psi]
MASS	0.6 kg
DISCHARGE CAPACITY [AT 7 bar/101 PSI]	167 l/h
INLET CONNECTION	G 1/2" (NPT option)
OUTLET CONNECTION	G 1/2" (NPT option)
DIMENSIONS A x B x C	135 x 110 x 130 mm
MEDIUM	Condensate (air, water, oil)
PART NUMBER	222394

Recommendations

Install ball valve between pressure vessel and inlet connection. Install strainer element between pressure vessel and inlet connection. Install nipple with venting tube to avoid generation of air bubbles. Nipple is screwed on inlet connection.





SAC 70
AUTOMATED CONDENSATE DRAIN



TECHNICAL DATA	
OPERATING TEMP. RANGE	1.5 - 65 °C [35-149 °F]
OPERATING PRESSURE	0 - 16 bar [0 - 232 psi]
MASS	0.04 kg
CONNECTION	G 1/2"
OUTLET CONNECTION	ø8
DIMENSIONS H x D	90 x ø38.5 mm
MEDIUM	Condensate (air, water, oil)
PART NUMBER	223120

MCD
MANUAL CONDENSATE DRAIN



TECHNICAL DATA		
OPERATING TEMP. RANGE	1.5 - 65 °C [35-149 °F]	
OPERATING PRESSURE	0-20 bar [290 psi]	
MASS	0.06 kg	
CONNECTION	G 1/2"	
DIMENSIONS	H	38.2 mm
	E	24.0 mm
MEDIUM	Condensate [air, water, oil]	
MATERIAL	Brass	
PART NUMBER	CC1183830	

CH SERIES OIL/WATER SEPARATORS

At a glance...



Capacity

2.5 - 60 m³/min



Outlet Connection

1/2" - 3/4"



Inlet Connection

1/2" - 2 x 3/4"

Unrivalled performance and efficiency

Environmental regulations strictly prohibit the discharge of oily wastes and chemicals, including the condensate drained from a compressed air system. This mixture of oil and water is classified as hazardous industrial waste, and the discharge of untreated compressor condensate into foul sewers is prohibited.

Compressor condensate must be either collected or treated before disposal using an oil water separator. Oil water separators remove lubricants from compressed air condensate ensuring environmentally friendly disposal. Considering that compressor condensate consists of approximately 95% water, it makes financial sense to separate the oil from the condensate before disposing of waste. Untreated condensate disposal is costly as it is charged by volume.

Every end-user that operates a compressed air system should have a condensate waste management program in place, not only to abide by laws and regulations but also to practice environmental and ecological responsibility. Champion oil water separators are a reliable, efficient, cost-effective, and environmentally friendly solution for on-site discharge of condensate from air compressors.

Modular design for enhanced performance

Modern industrial working environments present a host of challenges for effective and long-lasting oil water separation including ambient humidity and extreme temperatures, different coolant types, excessive operating hours, equipment age, compressor loading and residual oil.

To meet these challenges, Champion separators offer different sizes to match the customers needs. They feature adsorption media that withdraws and permanently adsorbs the lubricants.



Features are your benefits

Pre-filter removes contaminants

No fouling and clogging

Meets compressor flow requirements

Up to 60 m³/min

Complies with environmental regulations

Minimised fluid disposal costs

Streamlined design

Reliable operation with reduced maintenance



How it works

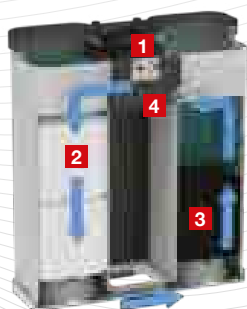

1. Oily water flows through the diffuser
2. First chamber, multiple Polypropylene media captures oil
3. Second chamber, Carbon media further removes oil
4. Clean water exits separator

The responsible choice

By minimising the cost associated with the disposal of fluids, and keeping them out of the environment, Champion oil water separators help you to stay compliant with environmental regulations and avoid costly fines. The separator is also designed to operate with minimal maintenance or downtime, resulting in no mess or overflow.

Champion separators provide condensate discharge levels < 10 ppm at standard conditions.

Guaranteed adsorption of a variety of coolants

Polypropylene and carbon media are effective on a big variety of polyalphaolefins lubricants and mineral oils available in the market.

Multiple sizing options

Champion oil water separators come in 10 standard sizes, handling air flow from 2.5 to 60 m³/min. The media is designed to last up to 6 months at 8,000 hours/year of operation and up to 12 months at 4,000 hours/year. Each model has standardised, modular media bags.

TECHNICAL DATA

OPERATING TEMP.RANGE	2 - 50°C
OPERATING MEDIA	Condensate (water - oil; Non aggressive) Not suitable for stabile condensate emulsion and polyglycol
DESIGN CONDITIONS	4 ppm Oil Carryover from compressor, 75% compressor loading, 20°C ambient and 70% RH
RESIDUAL OIL CONTENT	<15 ppm
SERVICE INTERVALS	When first of the following parameters appears: > 3 - 6 months if 8000 operating hours of compressor > 6 - 12 months if 4000 operating hours of compressor > when prefilter has oil built up

MODEL	CODE	CAPACITY [M ³ /MIN]	DIMENSIONS			WEIGHT [kg]
			[mm]	[mm]	[mm]	
CHS25	47716459001	2.5	590	200	245	6.5
CHS35	47716460001	3.5	590	200	245	7
CHS50	47716461001	5	645	510	170	9.5
CHS100	47716462001	10	830	700	206	17.5
CHS150	47716463001	15	830	700	206	20
CHS200	47716464001	20	830	700	206	22.5
CHS300	47716465001	30	1050	950	350	44.5
CHS400	47716466001	40	1050	950	350	50
CHS500	47716467001	50	1240	1065	410	65
CCHS600	47716468001	60	1240	1065	410	78

INDUSTRIAL CHILLERS

At a glance...



Cooling Capacity
0.8 - 365 kW

Contact the Champion
Sales Team for more information,
prices and brochure.

Champion can now offer a range of chillers and
coolers including Water Chillers, Oil Chillers,
Liquid Coolers and Air to Water Coolers

The Range



Water Chillers

CHW 09 - 3652

Cooling Capacity 1.1 - 365 kW

Especially designed for welders, inductors, food-packaging machinery, laser cutters, tooling machines, die-casting processes, molding and extruding processes of plastic materials, aerodynamic pumps and wine-making industry.

Low Temperature Water Chillers

CHG 08-1260

Cooling Capacity 0.8 - 126 kW

The low temperature liquid water chillers were designed to meet the needs of the chemical and food industries, to process and preserve products at temperatures near or below 0°C and are finding new industrial uses every day.





Liquid Coolers

CHA 99 - 150

Cooling Capacity: 1.3 - 150kW

Ideal for systems where an intermediate stage between the refrigerant circuit and the user one is necessary, equipped with pump and tank.

Air to Water Coolers

CHR 08 - 174

Cooling Capacity 0.8 - 174 kW

Air water liquid coolers, equipped with pump and tank, are suitable for cooling welders and spot welders, spindle and for all industrial applications that require liquid cooling at a temperature not lower than ambient one. Utilising forced air from the fan it is able to supply the outlet water at 5°C higher than the ambient temperature.



Oil Chillers

CHO 29 - 149

Cooling Capacity: 2.9 - 14.9 kW

The CHO series line is entirely dedicated to the sector of remote control machinery or those with hydraulic cooling. These machines constitute the best solution for the cooling of precision tooling machinery in a simple and prompt way.

EPL PIPING SYSTEM

EPL: The efficient alternative to traditional piping

The easy-to-install leak-free Champion EPL (Easy Pipe Line) system is your alternative to costly, labor-intensive steel pipe distribution systems for air, inert gas and vacuum lines. It leverages more than a century of Champion compressed air experience for streamlined installation, uncompromised reliable performance, effortless maintenance, flexibility for future needs, and maximum energy efficiency at the lowest total cost.

Modular design for enhanced performance

Modern industrial working environments present a host of challenges for effective and long-lasting oil water separation including ambient humidity and extreme temperatures, different coolant types, excessive operating hours, equipment age, compressor loading and residual oil.

To meet these challenges, Champion separators offer different sizes to match the customers needs. They feature adsorption media that withdraws and permanently adsorbs the lubricants.

Easier installation

- No special tools needed and specialised labor required
- Easy, safe installation with minimal downtime
- Patented quick-fit locking system provides fast installation and long-term operation
- Up to 60% less assembly time required than traditional piping
- 15% less assembly time required than alternative competitive modular piping systems
- EPL is compatible with existing piping systems and equipment
- Fully tested and certified to 97/23/EC and ASME B31.3 standards

Lower total cost

- Low initial investment
- Fully customizable and great configuration flexibility
- Low energy waste system, due to leak-free and low pressure drop design
- Less maintenance – up to 40% less labor and material costs than steel piping systems
- Corrosion-resistant to prevent contaminants and pressure losses
- Reusable parts for easy updates and modifications
- 10-year warranty protects your investment

Contact the Champion Sales Team for more information, prices and brochure.

No special tools, such as labor-intensive pipe-threading equipment, are required for the EPL system.

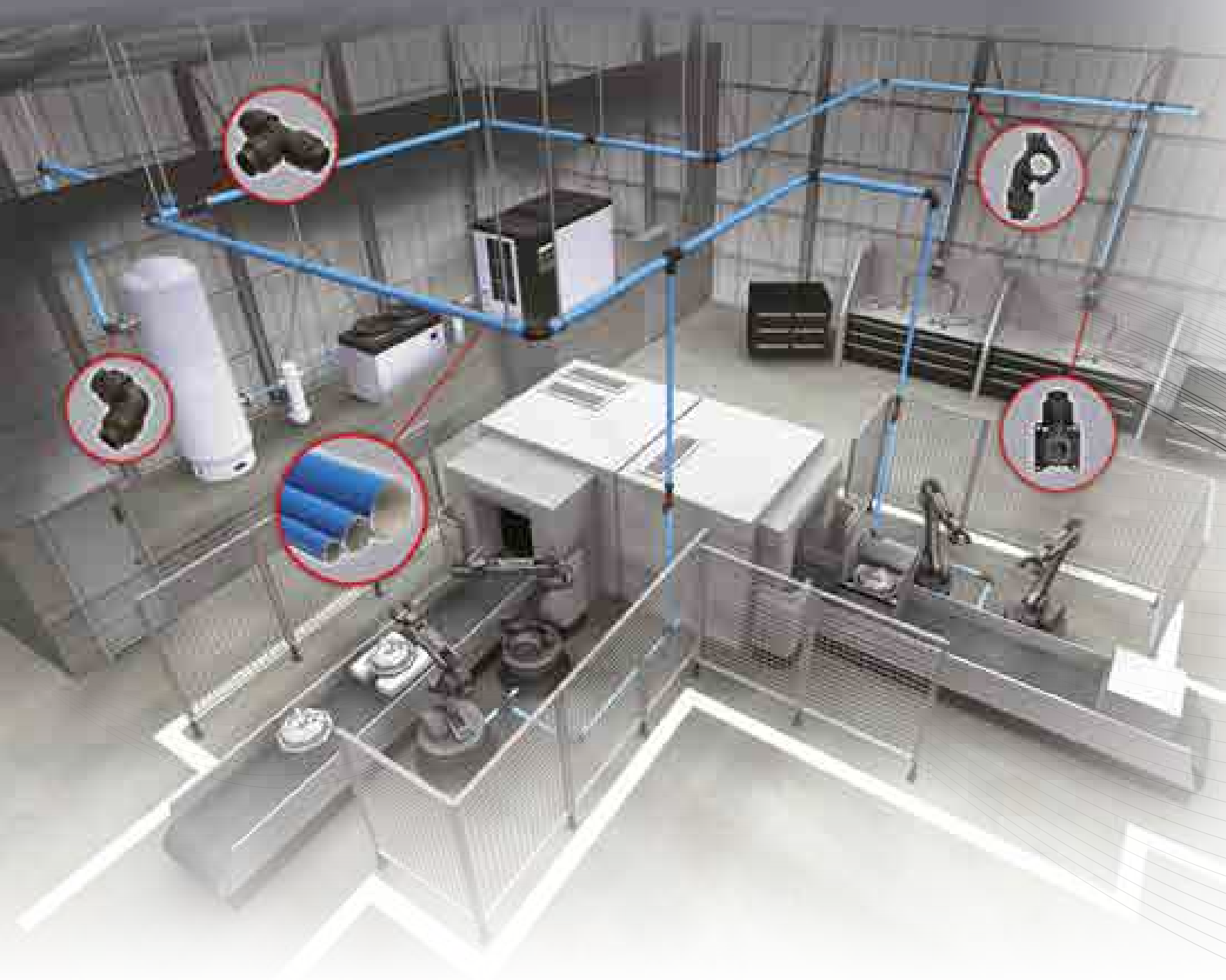

EPL: Simple to install

With a modular design and easy-to-assemble components, the EPL piping system empowers you to easily plan and adapt your distribution piping network to the needs of your production environment.

Intuitive, easy to assemble. No special tools or qualified personnel are required to assemble leak-free EPL systems.

Seamless maintenance. Patented by Champion, the innovative fitting design simplifies piping system assembly and disassembly, minimising downtime.

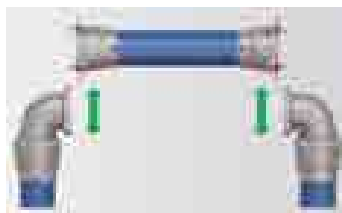

Tailored to your needs. An extensive variety of connectors, including those specifically developed for all Champion compressor and dryers ensure easy transition from current or competitive piping systems.

Standardised pipe length. Pipes are supplied in 5m lengths, eliminating special transportation arrangements to improve delivery times.

Versatile configuration. A wide variety of components and accessories combined with ease-of-assembly enables swift implementation with minimal downtime.

Preassembled productivity. Fully preassembled, ready-to-use fittings reduce installation time and number of components to order and stock.

Reconfigurable. Reusable connectors minimise incremental expenses when adapting or expanding existing piping to changing requirements.

Computer-aided design. The advanced EPL software tool makes it easier to develop and create your ideal leak-free air distribution system.

Personal support. Dedicated Champion sales personnel will ensure your questions are addressed before, during and after the system is installed.



SERVICE & SPARE PARTS

- Standard & Extended Warranty
- Service schedule
- Spare part kits





WARRANTY DURATION AND OPTIONS

• Warranty overview by model - range

MODEL - RANGE	WARRANTY DURATION	EXTENDED WARRANTY AVAILABLE
FM 2-6 Series Screw Compressors	24 Months ¹	X
FM07 - FM132 Series Screw Compressors	24 Months ¹	✓
Champion Vane Compressors CMPV01-V04	12 Months ¹	X
Champion Piston Compressors (C-Series)	12 Months ¹	✓ (see 2.4)
Champion Dental Compressors	12 Months ¹	X
Champion Breathing Air Compressors	12 Months ¹	X
Champion S Series Scroll Compressors	12 Months ¹	X
Champion Dryers (CHA, CHT, CHR)	24 Months ¹	✓
Champion Filters, Water Separators & Accessories	12 Months	X
Replacement Spare Parts	12 Months	X

¹ - The complete machine will have a warranty period of as mentioned above from date of commissioning or an additional 6 months from date of despatch ex Champion which ever is the soonest.

Champion recommends that only genuine Champion or approved parts be used, and that service be carried out by a authorised Champion trained service engineer.

• Replacement spare parts

The warranty period for replacement parts excluding air ends, motors and consumable spare parts shall be 12 months ex Champion The extent of this will be replacement part only.

Champion will not warrant adjacent components to the replacement part

Any defective spare part found prior to installation should be processed directly with the Champion parts department, not as a warranty claim.

• Extended warranty

CODE	DESCRIPTION
CC1180791	Extended Warranty 5 years for screw compressors 7.5 - 22 kW
CC1180793	Extended Warranty for screw compressors 30 - 132 kW
CC1180791	Extended Warranty for dryers

Champion offer an Extended Warranty programme on selected models. Additional fees and terms & conditions apply.

Please refer to the terms and conditions of the Extended Warranty Programmes.

Extended warranty prices are nett each, no extra discount can be applied.

For more information please see document : "Standard Warranty / Extended Warranty Terms & Conditions"

FM2 - FM6 SERVICE SCHEDULE

			DAILY ²	EVERY 500 HOURS ¹	EVERY 2000 HOURS OR 12 MONTHS ¹	EVERY 4000 HOURS OR 12 MONTHS ¹	EVERY 8000 HOURS OR 24 MONTHS ¹	EVERY 12000 HOURS OR 48 MONTHS ¹	EVERY 16000 HOURS OR 48 MONTHS ¹
SERVICE A	C-Pro Controller	Check fault indicator lights and alarms	•	•	•	•	•	•	•
	Condensate Drain and Strainer	Check autom. condensate discharger	•	•	•	•	•	•	•
	Air Tank	Discharge oil separator condensate	•	•	•	•	•	•	•
	Oil System	Check oil level	•	•	•	•	•	•	•
SERVICE C	Oil System	Check oil leaks			•	•	•	•	•
	General	Clean inside compressor			•	•	•	•	•
	Air Filter	Clean air filter			•	•	•	•	•
	Drive Belts	Check belt tension			•	•	•	•	•
	Electrical Wiring	Check connections and condition			•	•	•	•	•
	Relief Valve	Check operation of pressure relief valve			•	•	•	•	•
	Aftercooler/Oil Cooler	Clean cooler externally			•	•	•	•	•
	Oil System	Clean oil return line			•	•	•	•	•
	Oil Filter	Renew oil filter element			•	•	•	•	•
	Air Filter	Renew air filter element			•	•	•	•	•
	D	Separator Filter	Replace oil separator cartridges				•	•	•
Oil System		Renew oil (ChampLUBE)				•	•	•	•
SERVICE E	Valves	Refurbish Manifold					•		•
	Valves	Replace MPV element					•		•
	Probes	Replace temperature probe					•		•
	Valves	Replace inlet Valve					•		•
ADDITIONAL	Drive Belts	Replace the belts and check drive pulleys, replace if worn out						•	
	Probes	Replace Pressure Sensor							•
	Air End	Replace shaft seal kit							•
	Oil Hoses	Replace oil hoses							•
	Drive Motor	Check and retighten main motor cables							•
	Air End	Replace Air End							Predictive - only when required

1 Whichever occurs soonest

2 Normally undertaken by end user through visual check

Inspection of the pressure vessel in accordance with local guidelines

Where the compressor is part of an integrated unit, please refer to the separate dryer manual for any dryer related service tasks. Receiver certification beyond the initial period is the customers responsibility.

Please refer to the Operators handbook if there are specific local service requirements relevant to the territory you are in e.g. Oil and Filter change intervals which may be different to those shown above.

Service intervals will be shorter depending on the ambient operating conditions (heat, humidity, dirt etc.), affecting Lubricants, filters, separators etc.

FM7 - FM22 SERVICE SCHEDULE

			DAILY ²	WEEKLY ²	EVERY 4000 HOURS OR 12 MONTHS ¹	EVERY 8000 HOURS OR 24 MONTHS ¹	EVERY 20000 HOURS OR 60 MONTHS ¹	EVERY 24000 HOURS OR 72 MONTHS ¹
SERVICE A	Controller	Note and record sump pressure	•	•	•	•	•	•
	Controller	Note and record discharge pressure	•	•	•	•	•	•
	Controller	Note and record discharge temperature	•	•	•	•	•	•
	Enclosure Filters	Check condition, clean if required	•	•	•	•	•	•
	Scavenge oil system	Check operation	•	•	•	•	•	•
SERVICE B	Controller	Check fault history		•	•	•	•	•
	Controller	Check for any service requirements		•	•	•	•	•
	Oil System	Check oil level and top up if required		•	•	•	•	•
	Aftercooler/Oil Cooler	Check condition, clean if required		•	•	•	•	•
SERVICE C	Oil Filter	Renew oil filter element			•	•	•	•
	Air Filter	Renew air filter element			•	•	•	•
	Oil System	Renew oil (ChamplUBE)			•	•	•	•
	Dryer Cooling Air Inlet Filter ³	Renew cooling air inlet filter			•	•	•	•
	Control System	Check operation			•	•	•	•
	Blowdown System	Check operation			•	•	•	•
	Electrical Wiring	Check connections and condition			•	•	•	•
	Controller	Check connections and plugs			•	•	•	•
	Separator Filter	Renew separator filter			•	•	•	•
	Oil Scavenge System	Clean and check operation			•	•	•	•
	Relief Valve	Functionally test			•	•	•	•
	Drive Belts ³	Check condition of belts and renew if required			•	•	•	•
	SERVICE D	Minimum Pressure Valve	Renew minimum pressure valve					•
Intake Valve		Overhaul intake valve				•	•	•
Emergency Stop Button		Test emergency stop button				•	•	•
VSD Drive/Starter		Check condition of contacts and renew if required				•	•	•
ADDITIONAL	Air End	Renew air end shaft seal						•
	Shaft Seal Oil Return Tube	Renew shaft seal oil return tube						•
	Oil Hoses	Check condition and renew if required					•	•
	Control Solenoids	Renew control solenoids					•	•
	Drive Belts	Renew drive belts					•	•
	Drive Motor Bearings	Renew drive motor bearings						•
	Drive Motor AVM's	Check drive motor Anti Vibration Mounts						•
	Air End Discharge Temperature Sensor	Renew temperature sensor						•
	Oil Bypass Element	Renew oil bypass element						•
	Air End AVM's	Check air end Anti Vibration Mounts						•
Air End	Renew Air End							Predictive - only when required

¹ Whichever occurs soonest

² Normally undertaken by end user through visual check

³ If applicable

Inspection of the pressure vessel in accordance with local guidelines

Where the compressor is part of an integrated unit, please refer to the separate dryer manual for any dryer related service tasks. Receiver certification beyond the initial period is the customers responsibility.

Please refer to the Operators handbook if there are specific local service requirements relevant to the territory you are in e.g. Oil and Filter change intervals which may be different to those shown above.

Service intervals will be shorter depending on the ambient operating conditions (heat, humidity, dirt etc.), affecting Lubricants, filters, separators etc.

FM30 - 132 SERVICE SCHEDULE

			DAILY ²	WEEKLY ²	EVERY 4000 HOURS OR 12 MONTHS ¹	EVERY 8000 HOURS OR 24 MONTHS ¹	EVERY 20000 HOURS OR 60 MONTHS ¹	EVERY 24000 HOURS OR 72 MONTHS ¹
SERVICE A	Controller	Note and record sump pressure	•	•	•	•	•	•
	Controller	Note and record discharge pressure	•	•	•	•	•	•
	Controller	Note and record discharge temperature	•	•	•	•	•	•
	Enclosure Filters	Check condition, clean if required	•	•	•	•	•	•
	Scavenge oil system	Check operation	•	•	•	•	•	•
SERVICE B	Controller	Check fault history		•	•	•	•	•
	Controller	Check for any service requirements		•	•	•	•	•
	Oil System	Check oil level and top up if required		•	•	•	•	•
	Aftercooler/Oil Cooler	Check condition, clean if required		•	•	•	•	•
SERVICE C	Oil Filter	Renew oil filter element			•	•	•	•
	Air Filter	Renew air filter element			•	•	•	•
	Oil System	Renew oil (Mineral or Foodgrade)			•	•	•	•
	Oil System ⁵	Renew oil (Synthetic) AEON9000				•	•	•
	Dryer Cooling Air Inlet Filter ³	Renew cooling air inlet filter			•	•	•	•
	Control System	Check operation			•	•	•	•
	Blowdown System	Check operation			•	•	•	•
	Electrical Wiring	Check connections and condition			•	•	•	•
	Controller	Check connections and plugs			•	•	•	•
	Inlet Water Strainer ⁴	Check condition, clean if required			•	•	•	•
	Separator Filter	Renew separator filter			•	•	•	•
	Pipe work	Replace Victaulic Couplings			•	•	•	•
	Oil Scavenge System	Clean and check operation			•	•	•	•
	Relief Valve	Functionally test			•	•	•	•
SERVICE D	Oil Scavenge System	Renew oil scavenge tubing				•		•
	Minimum Pressure Valve	Renew minimum pressure valve				•		•
	Intake Valve	Overhaul intake valve				•		•
	Emergency Stop Button	Test emergency stop button				•		•
	Motor Drive Coupling Insert	Check condition and renew if required				•		•
	VSD Drive/Starter	Check condition of contacts and renew if required				•		•
	Air End	Renew air end shaft seal						•
ADDITIONAL	Shaft Seal Oil Return Tube	Renew shaft seal oil return tube						•
	Oil Hoses	Check condition and renew if required					•	•
	Control Solenoids	Renew control solenoids					•	•
	Drive Belts ³	Renew drive belts					•	•
	Drive Motor Bearings	Renew drive motor bearings						•
	Drive Motor AVM's	Check drive motor Anti Vibration Mounts						•
	Air End Discharge Temperature Sensor	Renew temperature sensor						•
	Oil Bypass Element	Renew oil bypass element						•
	Air End AVM's	Check air end Anti Vibration Mounts						•
	Air End	Renew Air End						

¹ Whichever occurs soonest

² Normally undertaken by end user through visual check

³ If applicable

Inspection of the pressure vessel in accordance with local guidelines

Where the compressor is part of an integrated unit, please refer to the separate dryer manual for any dryer related service tasks. Receiver certification beyond the initial period is the customers responsibility.

Please refer to the Operators handbook if there are specific local service requirements relevant to the territory you are in e.g. Oil and Filter change intervals which may be different to those shown above.

Service intervals could be shorter depending on the ambient operating conditions (heat, humidity, dirt etc.), effecting Lubricants, filters, separators etc. Service intervals could be shorter depending on the ambient operating conditions (heat, humidity, dirt etc.), effecting Lubricants, filters, separators etc.

VANE CMPV01-04 KW SERVICE SCHEDULE

	DAILY ²	WEEKLY ²	EVERY 2000 HOURS OR 12 MONTHS ¹	EVERY 4000 HOURS	EVERY 24000 HOURS
SERVICE A	Site-Adequate ventilation	•	•	•	•
	Site-Ambient temperature within limit	•	•	•	•
	Site-dust free ambient	•	•	•	•
	Check oil level at filler plug/sight glass	•	•	•	•
SERVICE B	Check for air leaks		•	•	•
	Check for oil leaks		•	•	•
	Check air intake filter/clean if necessary		•	•	•
	Check oil temperature		•	•	•
	Check RSU temperature		•	•	•
	Clean any external dirt from compressor		•	•	•
	Clean any external dirt from motor		•	•	•
SERVICE D	Change Separator cartridge			•	•
	Change 2000 hour oil			•	•
	Change air intake filter			•	•
	Check/Torque electrical connections			•	•
	Check power on load			•	•
	Check power off load			•	•
	Check servo pressure Off load			•	•
	Check motor gland/cables secure			•	•
	Check motor for damage			•	•
	Check motor / starter for loose connections			•	•
	Check motor cables and earth			•	•
	Check motor for vibration			•	•
	Check oil seal for leakage			•	•
	EXTRA	Grease motor bearings			•
Check starter contactors				•	•
OVERHAUL SERVICE	Change unloader valve seals				•
	Change MPV seals				•
	Change vacuum valve seals				•
	Change thermal motor				•
	Change drive media/key				•
	Change oil seal				•
	Change pressure gauge				•
	Change motor bearings				•
	Full Air End Inspection (internal)				•
	Clean servo filter				•
	Check correct drive rotation				•
	Check motor insulation resistance				•

¹ Whichever occurs soonest

² Normally undertaken by end user through visual check

Inspection of the pressure vessel in accordance with local guidelines

Please refer to the Operators handbook if there are specific local service requirements relevant to the territory you are in e.g. Oil and Filter change intervals which may be different to those shown above.

Service intervals could be shorter depending on the ambient operating conditions (heat, humidity, dirt etc.), effecting Lubricants, filters, separators etc. Service intervals could be shorter depending on the ambient operating conditions (heat, humidity, dirt etc.), effecting Lubricants, filters, separators etc.

SCROLL S04 & S07D UNITS SERVICE SCHEDULE

		DAILY ²	EVERY 500 HOURS OR 2 MONTHS ¹	EVERY 2000 HOURS OR 6 MONTHS ¹	EVERY 5000 HOURS OR 12 MONTHS ¹ 10 Bar	EVERY 10000 HOURS OR 24 MONTHS ¹ 8 Bar		
Complete Scroll Air End	Inspect for excessive noise and vibration	•						
Complete Scroll	Check for air Leaks	•						
Intake Air Filter	Clean and inspect		•					
V-Belts	Inspect and adjust V-Belts		•					
Intake Air Filter	Replace intake air filter			•	•	•		
Cooling	Inspect and clean cooler			•	•	•		
Sirocco Fan	Clean & inspect			•	•	•		
Airend Fin	Clean & inspect				•	•		
Scroll Bearings	Re-grease the bearing				•	•		
Tip Seals & Face Seals	Replace the seals				•	•		

¹ Maintenance time intervals are based on operating hours or calendar date, whichever occurs first.
If the compressor is operating at full pressure and is constantly running, reduce the service intervals by 25%

² Performed by the end user

Inspection of the pressure vessel in accordance with local guidelines

SCROLL S06, S08, S11D, S15D UNITS SERVICE SCHEDULE

		DAILY ²	EVERY 500 HOURS OR 2 MONTHS ¹	EVERY 2000 HOURS OR 12 MONTHS ¹	EVERY 5000 HOURS OR 24 MONTHS ¹ 10 Bar	EVERY 10000 HOURS OR 48 MONTHS ¹	EVERY 20000 HOURS OR 8 YEARS ¹ 8 Bar	EVERY 15000 HOURS OR 6 YEARS ¹ 10 Bar
Complete Scroll	Inspect for excessive noise and vibration	•						
Complete Scroll	Check for air leaks	•						
Intake Air Filter	Clean and inspect		•					
V-Beltss	Inspect and adjust V-Belts		•					
Intake Air Filter	Replace intake air filter			•	•	•		
Cooling	Inspect and clean cooler			•	•	•		
Cooling Fan & Scroll Fin	Clean & inspect			•	•	•		
Scroll Bearings	Re-grease the bearing				•	•		
Tip Seals & Face Seals	Replace the seals				•	•		
Brushes (7.5 Kw only)	Replace the Drum				•	•		
Scroll Airend	Replace the scroll airend						•	•

¹ Maintenance time intervals are based on operating hours or calendar date, whichever occurs first.
If the compressor is operating at full pressure and is constantly running, reduce the service intervals by 25%
For operating conditions where ambient temperature is higher than 77°F or 25°C the maintenance intervals are greatly reduced,
please refer to the manual for more information

² Performed by the end user

Inspection of the pressure vessel in accordance with local guidelines

PORTABLES CMP SERIES SERVICE SCHEDULE

		EACH START UP	FIRST 20 HOURS OF OPERATION	EVERY 100 HOURS OR 6 MONTHS ¹	EVERY 300 HOURS OR 12 MONTHS ¹	EVERY 24 MONTHS ¹
Compressor	Check safety valve	•	•	•	•	•
Compressor	Check retaining bolts & nuts (adjust if necessary)		•	•	•	•
Compressor	Check & clean oil filter		•	•	•	•
Compressor	Check & clean air filter			•	•	•
Compressor	Clean oil cooler			•	•	•
Compressor	Check the 2 belts tension (adjust if necessary)			•	•	•
Compressor	Drain & replace compressor oil		•	•	•	•
Compressor	Replace separator cartridge				•	•
Compressor	Replace air filter				•	•
Compressor	Replace belts					•
Engine	Drain & replace engine oil		•	•	•	•
Engine	Replace engine oil filter			•	•	•
Engine	Replace engine oil filler gasket				•	•
Engine	Replace engine air filter				•	•
Engine	Replace engine fuel filter				•	•
Engine	Replace engine spark plugs				•	•

¹ Maintenance time intervals are based on operating hours or calendar date, whichever occurs first.

Recommended oils -

The engine oil (2 liter) is included in the service kits. Champion only recommends this oil.

The compressor oil that is recommended is SCUO2000-5GT. Please ask your distributor for further information.

Fuel:- Use automotive gasoline (unleaded)

OIL LUBRICATED PISTON COMPRESSOR SERVICE SCHEDULE

C-Base, C-Line, C-Advanced, C-Pro, C-Engine series

	EVERY 50 HOURS	FEVERY 100 HOURS	WEEKLY	FULL MAINTENANCE/ SERVICE
Clean suction filter element	•	•		
Change oil in oil pump		•		
Drain condensate tank			•	•
Check oil level - top up if required			•	•
Replace filter element				•

SILENT PISTON COMPRESSOR SERVICE SCHEDULE

CS3, CS4, CS6, CS10, CS15 range

	EVERY 100 HOURS	FEVERY 500 HOURS	WEEKLY	MONTHLY	YEARLY
Drain condensate tank			•	•	•
Drain condensate - pressure switch			•	•	•
Clean suction filter element			•	•	•
Check oil level - top up if required	•				
Change oil in oil pump		•			
Replace filter element					•

C-SILENCED REFRIGERATION DRYER SERVICE SCHEDULE

	DAILY ²	WEEKLY	EVERY 4 MONTHS	EVERY 12 MONTHS
Controller	•			
Controller	•			
Condensate drain		•	•	•
Fins			•	•
Electrical			•	•
Refrigerant				•
Drain				•
Filtration				•

COMPRESSOR SERVICE KITS

SERVICE KITS OIL LUBRICATED SCREW COMPRESSORS							
		EVERY 2000 HOURS OR 12 MONTHS ¹	EVERY 4000 HOURS OR 12 MONTHS ¹	EVERY 8000 HOURS OR 24 MONTHS ¹	EVERY 16000 HOURS OR 48 MONTHS ¹	Overhaul kit Every 5 years or 20,000 hours	
FM2-FM6	Fixed Speed	CC1219905	CC1219906	CC1219907	CC1219908 + CC1219907		
FM7-11	Fixed Speed	CC1221491	CC1180671	CC1180677		CC1180682	+ 4K Kit
FM7RS-11RS	Regulated Speed	CC1221491	CC1180672	CC1180678		CC1180682	+ 4K Kit
FM15-22	Fixed Speed	CC1221492	CC1180685	CC1180689		CC1180695	+ 4K Kit
FM15RS-22RS	Regulated Speed	CC1221492	CC1180686	CC1180690		CC1180695	+ 4K Kit
FM30	Fixed Speed		CC1198084	CC1198090		CC1198096	+ 4K Kit
FM30RS	Regulated Speed		CC1198086	CC1198092		CC1198098	+ 4K Kit
FM37-45	Fixed Speed		CC1180685	CC1198091		CC1198097	+ 4K Kit
FM37RS-45RS	Regulated Speed		CC1198087	CC1198093		CC1198099	+ 4K Kit
FM55-75	Fixed Speed		CC1198088	CC1198094		CC1198100	+ 4K Kit
FM55RS-75RS	Regulated Speed		CC1198089	CC1198095		CC1198102	+ 4K Kit
FM90-132	Fixed Speed		SKFM90132-1	MKFM90132			
FM90RS-132RS	Regulated Speed		SKFM90132-1-RS	MKFM90132			

Only the following lubricants are allowed to be used to comply with Champion 5 Years Extended Warranty:

- Mineral lubricant ChampLUBE CC1180019 (4 x 4 L) - CC1180020 (20L)

SERVICE KITS OIL LUBRICATED SCREW COMPRESSORS (Legacy)				
		EVERY 2000 HOURS OR 12 MONTHS ¹	EVERY 4000 HOURS OR 12 MONTHS ¹	EVERY 8000 HOURS OR 24 MONTHS ¹
KA2-KA5		CC1089648	CC1089649	CC1089650
KA7+		CC1089652	CC1125190	CC1125192
KSA - KSV30			CC1121434	CC1121435
KSA - KSV 37-45			CC1121437	CC1121438
KSA 55 - 75	Fixed Speed		CC1154033	CC1154034
KSV 55 - 75	Regulated Speed		CC1154035	CC1154036
KSA11			CC1089657	CC1089658
KBV KSB 15 - 22			CC1178518	CC1180296
KSA90			CC1154033	CC1154034
KSV90			CC1154035	CC1154036

Only the following lubricants are allowed to be used to comply with Champion 5 Years Extended Warranty:

- Mineral lubricant ChampLUBE CC1180019 (4 x 4 L) - CC1180020 (20L)

SERVICE KITS OIL LUBRICATED VANE COMPRESSORS

		EVERY 2000 HOURS OR 12 MONTHS ¹	EVERY 24000 HOURS
CMPV01, CMPV02	Fixed Speed	C-AK0102	C-OK0102
CMPV04	Fixed Speed	C-AK04	C-OK04

Only the following lubricants are allowed to be used: Mineral lubricant ChampLUBE Vane Lubricant CC1180033 (1L)

¹ Maintenance time intervals are based on operating hours or calendar date, whichever occurs first.

Champion will not accept any responsibility for changes made to service kit numbers, prior to updating this document.

For belts, hoses, shaft seal kits and all other repair spare parts please consult the relevant parts lists

SERVICE KITS PORTABLE SCREW COMPRESSORS

	AIR END KIT EVERY 300 HOURS OR 12 MONTHS ¹	ENGINE KIT EVERY 300 HOURS OR 12 MONTHS ¹
CMP-P10, CMP-P12, CMP-P14	CC1186378	CC1186379

Only the following lubricants are allowed to be used: Mineral lubricant SCUO2000-5GT

¹ Maintenance time intervals are based on operating hours or calendar date, whichever occurs first.

Champion will not accept any responsibility for changes made to service kit numbers, prior to updating this document.

For belts and all other repair spare parts please consult the relevant parts lists

SERVICE KITS OIL FREE SCROLL COMPRESSORS

		\$04, \$06, \$08	\$07D, \$11D, \$15D
300SMB1445	Air Filter (4kW x 1, 6 & 8kW x 2)	x 1	x 2
300SMB6029	Tip seal kit 2 & 4kW	x 1	x 2
300SMB6022	Grease 80 grams	Refer to manual for quantities	
302SIA6003	Kit 6kW Bushing & spring	x 1	x 2
300SIA6003	Kit 6kW Service kit (includes tip seal, face seal & grease)	x 1	x 2
301SIA6003	Kit 7kW Service kit (includes tip seal, face seal & grease)	x 1	x 2
300SMB6031	Grease gun		

SERVICE KITS PISTON COMPRESSORS

C-Base, C-Line, C-Advanced, C-Pro, C-Engine series

MODEL RANGES	GASKET KIT	VALVE PLATE KIT	INTAKE FILTER	NRV
CA3 ; CL3 ; CS3	CC55886980NC	CC91894881NC	CC55875132NC	CC55894513NC
CA4 ; CP4 ; CS4	CC92060037NC	CC97155576NC	CC55875132NC	CC55894513NC
CA5 ; CL5	CC55893648NC	CC55893622NC	CC55898936NC	CC55894521NC
CA6; CP6 ; CS6	CC97241376NC	CC97159594NC	CC55898936NC	CC55894521NC
CA10 ; CL10 ; CP10 ; CS10	CC55893655NC	CC55894133NC	CC55898936NC	CC55894521NC
CA15 ; CP15 ; CS15	CC55894224NC	CC55894141NC	CC55898936NC	CC55894521NC
CA28 ; CL28 ; CP28	CC97251615NC	CC91894881NC	CC55875140NC	CC97160634NC
CB-100-CM2 CB-24-CM2 CB-3-CF2 CB-50-CM2	CC55899108NC	CC55899090NC	CC55899132NC	CC97160634NC
CB-100-CM3 CB-24-WB3 CB-50-CM3 CB-50V-CM3	CC55899405NC	CC55899090NC	CC55899132NC	CC55904375NC
CB-100-CM25 CB-24-CM25 CB-50-CM25		CC55899090NC	CC55890079NC	CC97160634NC
CB6			CC55890087NC	

Only the following lubricants are allowed to be used

- SAE40 - Viscosity 100

CHAMPION CHR6 - CHR417 REFRIGERATION DRYER SERVICE SCHEDULE

		DAILY	WEEKLY	MONTHLY	EVERY 12 MONTHS OR 2000 HOURS	EVERY 24 MONTHS OR 4000 HOURS
Dryer	Verify the temperature on the control panel display is acceptable	•	•	•	•	•
Condensate Drain	Visually check if the condensate is drained regularly	•	•	•	•	•
Dryer	Clean the filter mesh of the condensate drain system		•	•	•	•
Dryer	Clean condenser fins.			•	•	•
Dryer	Check electrical absorption			•	•	•
Filter	Check the conditions of the filters installed, replace elements as needed			•	•	•
Dryer	Check if flexible tube used for condensate drainage is damaged and replace if necessary				•	•
Dryer	Check if all connecting pipes are properly tightened and fixed				•	•
Filter	Depressurise the dryer. Replace pre- and post-filter elements.				•	•
Dryer	Replace the fan pressure switch					•

ADSORPTION AIR DRYERS CHAMPION CHA-DRY SERVICE SCHEDULE

		DAILY ²	EVERY 2000 HOURS OR 3 MONTHS ¹	EVERY 8000 HOURS OR 12 MONTHS ¹	EVERY 16000 HOURS OR 24 MONTHS ¹	EVERY 56000 HOURS OR 48 MONTHS ¹
Dryer	Check POWER ON indicator is illuminated	•				
Dryer	Check STATUS / FAULT indicators located on the controller.	•				
Dryer	Check for air leaks	•				
Dryer	Check the condition of electrical supply cables and conduits.		•	•	•	•
Dryer	Check for cyclic operation.			•	•	•
Filtration	Check Drain operation		•	•	•	•
A	Dryer			†	†	†
B	Filtration			†	†	†
D	Dryer				†	†
E	Dryer					†

¹ Maintenance time intervals are based on operating hours or calendar date, whichever occurs first. • Performed by the operator † Essential maintenance - Service personnel only

KITS FOR CHA-DRY 6 - 200

	KIT PART NUMBER		
A	CC1182876	1 year silencer replacement kit 06-36	2 x purge exhaust silencer
	CC1182877	1 year silencer replacement kit 75-105	2 x purge exhaust silencer
	CC1182878	1 year silencer replacement kit 150-200	2 x purge exhaust silencer
D	CC1182832	2 year replacement kit 06	4 x replacement control valves
	CC1182835	2 year replacement kit 12	2 x replacement non-return valves
	CC1182818	2 year replacement kit 24	4 x sealing O-ring
	CC1182820	2 year replacement kit 36	2 x nozzle
			2 x purge exhaust silencer
	CC1182821	2 year replacement kit 60	4 x replacement control valves
	CC1182822	2 year replacement kit 75	2 x replacement non-return valves
	CC1182823	2 year replacement kit 105	4 x sealing O-ring
			2 x nozzle
			2 x purge exhaust silencer
	CC1182854	2 year replacement kit 150	4 x replacement control valves
	CC1182855	2 year replacement kit 200	4 x replacement non-return valves
			4 x sealing O-ring
			2 x nozzle
			2 x purge exhaust silencer
E	CC1182857	KIT Service CHA-DRY 06/48 48 months replacement kit	1 x 2 year replacement kit 06-36 2 x tower tubes including molecular sieve for A-DRY 06
	CC1182858	KIT Service CHA-DRY 12/48 48 months replacement kit	1 x 2 year replacement kit 06-36 2 x tower tubes including molecular sieve for A-DRY 12
	CC1182859	KIT Service CHA-DRY 24/48 48 months replacement kit	1 x 2 year replacement kit 06-36 2 x tower tubes including molecular sieve for A-DRY 24
	CC1182860	KIT Service CHA-DRY 36/48 48 months replacement kit	1 x 2 year replacement kit 06-36 2 x tower tubes including molecular sieve for A-DRY 32
	CC1182861	KIT Service CHA-DRY 60/48 48 months replacement kit	1 x 2 year replacement kit 60-105 2 x tower tubes including molecular sieve for A-DRY 60
	CC1182862	KIT Service CHA-DRY 75/48 48 months replacement kit	1 x 2 year replacement kit 60-105 2 x tower tubes including molecular sieve for A-DRY 75
	CC1182863	KIT Service CHA-DRY 105/48 48 months replacement kit	1 x 2 year replacement kit 60-105 2 x tower tubes including molecular sieve for A-DRY 105
	CC1182874	KIT Service CHA-DRY 150/48 48 months replacement kit	1 x 2 year replacement kit 150-200 2 x tower tubes including molecular sieve for A-DRY 150
	CC1182875	KIT Service CHA-DRY 200/48 48 months replacement kit	1 x 2 year replacement kit 150-200 2 x tower tubes including molecular sieve for A-DRY 200

ADSORPTION AIR DRYERS CHAMPION CHB-DRY SERVICE SCHEDULE

			DAILY ²	EVERY 2000 HOURS OR 3 MONTHS ¹	EVERY 8000 HOURS OR 12 MONTHS ¹	EVERY 16000 HOURS OR 24 MONTHS ¹	EVERY 56000 HOURS OR 48 MONTHS ¹
	Dryer	Check POWER ON indicator is illuminated	•				
	Dryer	Check STATUS / FAULT indicators located on the controller.	•				
	Dryer	Check for air leaks	•				
	Dryer	Check the condition of electrical supply cables and conduits.		•	•	•	•
	Dryer	Check for cyclic operation			•	•	•
	Filtration	Check Drain operation		•	•	•	•
A	Dryer	Replace active exhaust silencers Recommended Service A			†	†	†
B	Filtration	Replace the inlet and outlet air filters and service drains. Recommended Service B			†	†	†
D	Dryer	Replace valves Recommended Service C				†	†
E	Dryer	Replace the Desiccant. Recommended Service E					†
	Dryer	Clean/Replace Strainers					†
	Dryer	Calibrate Dew-point sensor (optional)			†		

¹ Maintenance time intervals are based on operating hours or calendar date, whichever occurs first. • Performed by the operator † Essential maintenance - Service personnel only

KITS FOR CHB-DRY 110 - 1000

	KIT PART NUMBER		
A	CC1182775	Silencer kit CHB-DRY 110-250	Silencer service kit for B-DRY 110/150/200/250
	CC1182776	Silencer kit CHB-DRY 300-600	Silencer service kit for B-DRY 300/400/600
	CC1182777	Silencer kit CHB-DRY 800-1000	Silencer service kit for B-DRY 800/1000
D	CC1182893	KIT SERVIS CHB-DRY 110-250/24	Control valves replacement components
		24 months replacement kit	
	CC1182894	KIT SERVIS CHB-DRY 300-600/24	Check valves replacement components
		24 months replacement kit	Silencer service kit
	CC1182895	KIT SERVIS CHB-DRY 800-1000/24	Check valves replacement components
		24 months replacement kit	Silencer service kit
E	CC1182746	KIT SERVIS CHB-DRY 110/48	Control valves replacement components
		48 months replacement kit	Check valves replacement components Silencer service kit
	CC1182747	KIT SERVIS CHB-DRY 150/48	Control valves replacement components
		48 months replacement kit	Check valves replacement components Silencer service kit
	CC1182748	KIT SERVIS CHB-DRY 200/48	Control valves replacement components
		48 months replacement kit	Check valves replacement components Silencer service kit
	CC1182749	KIT SERVIS CHB-DRY 250/48	Control valves replacement components
		48 months replacement kit	Check valves replacement components Silencer service kit
	CC1182750	KIT SERVIS CHB-DRY 300/48	Control valves replacement components
		48 months replacement kit	Check valves replacement components Silencer service kit
	CC1182751	KIT SERVIS CHB-DRY 400/48	Control valves replacement components
		48 months replacement kit	Check valves replacement components Silencer service kit
	CC1182752	KIT SERVIS CHB-DRY 600/48	Control valves replacement components
		48 months replacement kit	Check valves replacement components Silencer service kit
	CC1182753	KIT SERVIS CHB-DRY 800/48	Control valves replacement components
	48 months replacement kit	Check valves replacement components Silencer service kit	
CC1182774	KIT SERVIS CHB-DRY 1000/48	Control valves replacement components	
	48 months replacement kit	Check valves replacement components Silencer service kit	

ADSORPTION AIR DRYERS CHAMPION CHX-DRY SERVICE SCHEDULE

		DAILY	EVERY 2000 HOURS OR 3 MONTHS ¹⁾	EVERY 8000 HOURS OR 12 MONTHS ¹⁾	EVERY 16000 HOURS OR 24 MONTHS ¹⁾	EVERY 56000 HOURS OR 48 MONTHS ¹⁾
	Dryer	Check POWER ON indicator is illuminated	•			
	Dryer	Check STATUS / FAULT indicators located on the controller.	•			
	Dryer	Check for air leaks	•			
	Dryer	Check the condition of electrical supply cables and conduits.		•	•	•
	Dryer	Check for cyclic operation.			•	•
	Filtration	Check Drain operation		•	•	•
A	Dryer	Replace active exhaust silencers Recommended Service A			†	†
B	Filtration	Replace the inlet and outlet air filters and service drains. Recommended Service B			†	†
D	Dryer	Replace valves Recommended Service C				†
E	Dryer	Replace the Desiccant. Recommended Service E				†
	Dryer	Clean/Replace Strainers				†
	Dryer	Calibrate Dew-point sensor (optional)			†	

¹⁾ Maintenance time intervals are based on operating hours or calendar date, whichever occurs first. • Performed by the operator † Essential maintenance - Service personnel only

KITS FOR CHX-DRY 350 - 1050

	KIT PART NUMBER		
A	CC1182891	Silencer CHX-DRY 300-1050	Silencer service X-DRY 300-1050
D	CC1182879	KIT Service CHX-DRY 300/24	Control and check valves replacement components
		24 months replacement kit	Silencer service kit
	CC1182880	KIT Service CHX-DRY 450/24	Control and check valves replacement components
		24 months replacement kit	Silencer service kit
	CC1182881	KIT Service CHX-DRY 600/24	Control and check valves replacement components
		24 months replacement kit	Silencer service kit
	CC1182882	KIT Service CHX-DRY 750/24	Control and check valves replacement components
		24 months replacement kit	Silencer service kit
E	CC1182883	KIT Service CHX-DRY 900/24	Control and check valves replacement components
		24 months replacement kit	Silencer service kit
	CC1182884	KIT Service CHX-DRY 1050/24	Control and check valves replacement components
		24 months replacement kit	Silencer service kit
	CC1182885	KIT Service CHX-DRY 300/48	Control and check valves replacement components
		48 months replacement kit	Silencer service kit Adsorbent
	CC1182886	KIT Service CHX-DRY 450/48	Control and check valves replacement components
		48 months replacement kit	Silencer service kit Adsorbent
E	CC1182887	KIT Service CHX-DRY 600/48	Control and check valves replacement components
		48 months replacement kit	Silencer service kit Adsorbent
	CC1182888	KIT Service CHX-DRY 750/48	Control and check valves replacement components
		48 months replacement kit	Silencer service kit Adsorbent
	CC1182889	KIT Service CHX-DRY 900/48	Control and check valves replacement components
		48 months replacement kit	Silencer service kit Adsorbent
E	CC1182890	KIT Service CHX-DRY 1050/48	Control and check valves replacement components
		48 months replacement kit	Silencer service kit Adsorbent

CH-FT ACTIVATED CARBON TOWER SERVICE KITS

MODEL	CODE
Kit CHFT5L Champion	47752199001
Kit CHFT12L Champion	47752200001
Kit CHFT18L Champion	47752201001
Kit CHFT25L Champion	47752202001
Kit CHFT30L Champion	47752203001
Kit CHFT58L Champion	47752204001
Kit CHFT100L Champion	47752205001
Kit CHFT166L Champion	47752206001
Kit CHFT260L Champion	47752207001
Kit CHFT383L Champion	47752208001
Kit CHFT466L Champion	47752209001
Kit CHFT950L Champion	47752210001

FILTER GUIDE

FILTER TYPE	M ³ /MIN	SIZE	FILTER ID NO	FILTER ELEMENT	ELEMENT NO
CHF005LM	0.5	3/8"	47698906001	CHE005LM	47699428001
CHF005LS	0.5	3/8"	47698923001	CHE005LS	47699429001
CHF005LR	0.5	3/8"	47698940001	CHE005LR	47699430001
CHF005LA	0.5	3/8"	47698957001	CHE005LA	47699431001
CHF007LM	0.7	1/2"	47698907001	CHE007LM	47699432001
CHF007LS	0.7	1/2"	47698924001	CHE007LS	47699433001
CHF007LR	0.7	1/2"	47698941001	CHE007LR	47699434001
CHF007LA	0.7	1/2"	47698958001	CHE007LA	47699435001
CHF0013LM	1.3	3/4"	47698908001	CHE0013LM	47699436001
CHF0013LS	1.3	3/4"	47698925001	CHE0013LS	47699437001
CHF0013LR	1.3	3/4"	47698942001	CHE0013LR	47699438001
CHF0013LA	1.3	3/4"	47698959001	CHE0013LA	47699439001
CHF0018LM	1.8	3/4"	47698909001	CHE0018LM	47699440001
CHF0018LS	1.8	3/4"	47698926001	CHE0018LS	47699441001
CHF0018LR	1.8	3/4"	47698943001	CHE0018LR	47699442001
CHF0018LA	1.8	3/4"	47698960001	CHE0018LA	47699443001
CHF0025LM	2.5	1"	47698910001	CHE0025LM	47699444001
CHF0025LS	2.5	1"	47698927001	CHE0025LS	47699445001
CHF0025LR	2.5	1"	47698944001	CHE0025LR	47699446001
CHF0025LA	2.5	1"	47698961001	CHE0025LA	47699447001
CHF0032LM	3.2	1"	47698911001	CHE0032LM	47699448001
CHF0032LS	3.2	1"	47698928001	CHE0032LS	47699449001
CHF0032LR	3.2	1"	47698945001	CHE0032LR	47699450001
CHF0032LA	3.2	1"	47698962001	CHE0032LA	47699451001
CHF0038LM	3.8	1"	47698912001	CHE0038LM	47699452001
CHF0038LS	3.8	1"	47698929001	CHE0038LS	47699453001
CHF0038LR	3.8	1"	47698946001	CHE0038LR	47699454001
CHF0038LA	3.8	1"	47698963001	CHE0038LA	47699455001
CHF0067LM	6.7	1 1/2"	47698913001	CHE0067LM	47699456001
CHF0067LS	6.7	1 1/2"	47698930001	CHE0067LS	47699457001
CHF0067LR	6.7	1 1/2"	47698947001	CHE0067LR	47699458001
CHF0067LA	6.7	1 1/2"	47698964001	CHE0067LA	47699459001
CHF0082LM	8.2	1 1/2"	47698914001	CHE0082LM	47699460001
CHF0082LS	8.2	1 1/2"	47698931001	CHE0082LS	47699461001
CHF0082LR	8.2	1 1/2"	47698948001	CHE0082LR	47699462001
CHF0082LA	8.2	1 1/2"	47698965001	CHE0082LA	47699463001
CHF0100LM	10.0	2"	47698915001	CHE0100LM	47699464001
CHF0100LS	10.0	2"	47698932001	CHE0100LS	47699465001
CHF0100LR	10.0	2"	47698949001	CHE0100LR	47699466001
CHF0100LA	10.0	2"	47698966001	CHE0100LA	47699467001
CHF0133LM	13.3	2"	47698916001	CHE0133LM	47699468001
CHF0133LS	13.3	2"	47698933001	CHE0133LS	47699469001
CHF0133LR	13.3	2"	47698950001	CHE0133LR	47699470001
CHF0133LA	13.3	2"	47698967001	CHE0133LA	47699471001
CHF0167LM	16.7	2"	47698917001	CHE0167LM	47699472001
CHF0167LS	16.7	2"	47698934001	CHE0167LS	47699473001
CHF0167LR	16.7	2"	47698951001	CHE0167LR	47699474001
CHF0167LA	16.7	2"	47698968001	CHE0167LA	47699475001
CHF0200LM	20.0	3"	47698918001	CHE0200LM	47699476001
CHF0200LS	20.0	3"	47698935001	CHE0200LS	47700078001
CHF0200LR	20.0	3"	47698952001	CHE0200LR	47700079001
CHF0200LA	20.0	3"	47698969001	CHE0200LA	47700080001
CHF0260LM	26.0	3"	47698919001	CHE0260LM	47700081001
CHF0260LS	26.0	3"	47698936001	CHE0260LS	47700082001
CHF0260LR	26.0	3"	47698953001	CHE0260LR	47700083001
CHF0260LA	26.0	3"	47698970001	CHE0260LA	47700084001
CHF0305LM	30.5	3"	47698920001	CHE0305LM	47700085001
CHF0305LS	30.5	3"	47698937001	CHE0305LS	47700086001
CHF0305LR	30.5	3"	47698954001	CHE0305LR	47700087001
CHF0305LA	30.5	3"	47698971001	CHE0305LA	47700088001
CHF0038LM	38.3	3"	47698921001	CHE0038LM	47700089001
CHF0038LS	38.3	3"	47698938001	CHE0038LS	47700090001
CHF0038LR	38.3	3"	47698955001	CHE0038LR	47700091001
CHF0038LA	38.3	3"	47698972001	CHE0038LA	47700092001
CHF0450LM	45.0	3"	47698922001	CHE0450LM	47700093001
CHF0450LS	45.0	3"	47698939001	CHE0450LS	47700094001
CHF0450LR	45.0	3"	47698956001	CHE0450LR	47700095001
CHF0450LA	45.0	3"	47698973001	CHE0450LA	47700096001

FILTER ELEMENTS MUST BE REPLACED AT LEAST EVERY 12 MONTHS

FILTER GUIDE

FILTER TYPE	M ³ /MIN	SIZE	FILTER ID NO	FILTER ELEMENT	ELEMENT NO
CERAMIC PRE-FILTERS 3 MICRON					
F 005 P	1	3/8"	223051A	Filter Cartridge F005P	223171
F 007 P	1.3	1/2"	223052A	Filter Cartridge F007P	223172
F 010 P	2	3/4"	223053A	Filter Cartridge F010P	223173
F 018 P	3.3	1 "	223054A	Filter Cartridge F018P	223174
F 030 P	5.5	1 "	223055A	Filter Cartridge F030P	223175
F 047 P	8.5	1 1/2"	223056A	Filter Cartridge F047P	223176
F 070 P	13	1 1/2"	223057A	Filter Cartridge F070P	223177
F 094 P	16.6	2"	223058A	Filter Cartridge F094P	223178
F 150 P	25	2"	223059A	Filter Cartridge F150P	223179
F 200 P	36	3"	CC1182427	Filter Cartridge F200P	CC1183012
F 240 P	46	3"	223060A	Filter Cartridge F240P	223180
COALESCENT FILTERS 0.1 MICRON					
F 005 R	1	3/8"	CC1185088	Filter Cartridge F005R	CC1185073
F 007 R	1.3	1/2"	CC1185089	Filter Cartridge F007R	CC1185074
F 010 R	2	3/4"	CC1185090	Filter Cartridge F010R	CC1185075
F 018 R	3.3	1 "	CC1185091	Filter Cartridge F018R	CC1185076
F 030 R	5.5	1 "	CC1185092	Filter Cartridge F030R	CC1185077
F 047 R	8.5	1 1/2"	CC1185093	Filter Cartridge F047R	CC1185078
F 070 R	13	1 1/2"	CC1185094	Filter Cartridge F070R	CC1185079
F 094 R	16.6	2"	CC1185095	Filter Cartridge F094R	CC1185080
F 150 R	25	2"	CC1185096	Filter Cartridge F150R	CC1185081
F 200 R	36	3"	CC1185097	Filter Cartridge F200R	CC1185082
F 240 R	46	3"	CC1185098	Filter Cartridge F240R	CC1185083
COALESCENT FILTERS 0.1 MICRON					
F 005 M	1	3/8"	223061A	Filter Cartridge F005M	223181
F 007 M	1.3	1/2"	223062A	Filter Cartridge F007M	223182
F 010 M	2	3/4"	223063A	Filter Cartridge F010M	223183
F 018 M	3.3	1"	223065A	Filter Cartridge F018M	223184
F 030 M	5.5	1"	223066A	Filter Cartridge F030M	223185
F 047 M	8.5	1 1/2"	223067A	Filter Cartridge F047M	223186
F 070 M	13	1 1/2"	223068A	Filter Cartridge F070M	223187
F 094 M	16.6	2"	223069A	Filter Cartridge F094M	223188
F 150 M	25	2"	223081A	Filter Cartridge F150M	223189
F 200 M	36	3"	CC1182428	Filter Cartridge F200M	CC1183034
F 240 M	46	3"	223064A	Filter Cartridge F240M	223190
COALESCENT FILTERS 0.01 MICRON					
F 005 S	1	3/8"	223070A	Filter Cartridge F005S	223191
F 007 S	1.3	1/2"	223071A	Filter Cartridge F007S	223192
F 010 S	2	3/4"	223072A	Filter Cartridge F010S	223193
F 018 S	3.3	1"	223073A	Filter Cartridge F018S	223194
F 030 S	5.5	1"	223074A	Filter Cartridge F030S	223195
F 047 S	8.5	1 1/2"	223075A	Filter Cartridge F047S	223196
F 070 S	13	1 1/2"	223076A	Filter Cartridge F070S	223197
F 094 S	16.6	2"	223077A	Filter Cartridge F094S	223198
F 150 S	25	2"	223078A	Filter Cartridge F150S	223199
F 200 S	36	2 1/2"	CC1182429	Filter Cartridge F200S	CC1183035
F 240 S	46	3"	223079A	Filter Cartridge F240S	223200
ACTIVATED CARBON FILTERS 0.005 MICRON					
F 005 A	1	3/8"	223090A	Filter Cartridge F005A	223211
F 007 A	1.3	1/2"	223091A	Filter Cartridge F007A	223212
F 010 A	2	3/4"	223092A	Filter Cartridge F010A	223213
F 018 A	3.3	1"	223093A	Filter Cartridge F018A	223214
F 030 A	5.5	1"	223094A	Filter Cartridge F030A	223215
F 047 A	8.5	1 1/2"	223095A	Filter Cartridge F047A	223216
F 070 A	13	1 1/2"	223096A	Filter Cartridge F070A	223217
F 094 A	16.6	2"	223097A	Filter Cartridge F094A	223218
F 150 A	25	2"	223098A	Filter Cartridge F150A	223219
F 200 A	36	3"	CC1182430	Filter Cartridge F200A	CC1183036
F 240 A	46	3"	223099A	Filter Cartridge F240A	223220

FILTER ELEMENTS MUST BE REPLACED AT LEAST EVERY 12 MONTHS

FILTER GUIDE

FILTER TYPE	M ³ /MIN	SIZE	FILTER ID NO	FILTER ELEMENT	ELEMENT NO
CONDENSATION SEPARATING FILTERS					
F 005 W	1	3/8"	CC1177720	Filter Cartridge F 005W	CC1188141
F 007 W	1.3	1/2"	CC1177721	Filter Cartridge F 007W	CC1188142
F 010 W	2	3/4"	223101A	Filter Cartridge F 010W	CC1183037
F 030 W	3.3	1"	223102A	Filter Cartridge F 030W	CC1183038
F 070 W	8.5	1 1/2"	223103A	Filter Cartridge F 070W	CC1183039
F 094 W	16.6	2"	CC1181853	Filter Cartridge F 094W	CC1183040
F 150 W	25	2"	223104A	Filter Cartridge F 150W	CC1183041
F 200 W	36	2 1/2"	CC1182432	Filter Cartridge F 200W	CC1183042
CH-MDRY MEMBRANE FILTERS					
CHM-DRY 3	0.05	1/4"	CC1189577	Membrane CHM-DRY 3	CC1189462
CHM-DRY 6	0.1	1/4"	CC1189578	Membrane CHM-DRY 6	CC1189463
CHM-DRY 9	0.15	1/4"	CC1189579	Membrane CHM-DRY 9	CC1189464
CHM-DRY 12	0.2	1/4"	CC1189580	Membrane CHM-DRY 12	CC1189465
CHM-DRY 18	0.3	1/2"	CC1189581	Membrane CHM-DRY 18	CC1189466
CHM-DRY 24	0.4	1/2"	CC1189582	Membrane CHM-DRY 24	CC1189467
CHM-DRY 32	0.6	1/2"	CC1189583	Membrane CHM-DRY 32	CC1189468
CHM-DRY 44	0.8	1/2"	CC1189584	Membrane CHM-DRY 44	CC1189469
CHM-DRY 63	1.05	1/2"	CC1189585	Membrane CHM-DRY 63	CC1189470
CHM-DRY 90	1.5	1/2"	CC1189586	Membrane CHM-DRY 90	CC1189471
CHM-DRY 123	2.05	1/2"	CC1189587	Membrane CHM-DRY 123	CC1189472
CHM-DRY 180	3	1/2"	CC1189588	Membrane CHM-DRY 180	CC1189473

CHB-AIR BREATHING AIR FILTRATION SYSTEMS						
FILTER TYPE	ELEMENT TYPE (FM)	ELEMENT NO	ELEMENT TYPE (F-H2M)	ELEMENT NO	ELEMENT TYPE (F-A2)	ELEMENT NO
CHB-AIR 76	Filter Cartridge F007M	223182	Filter Cartridge F007H2	CC1189441	Filter Cartridge F007A2	CC1189354
CHB-AIR 106	Filter Cartridge F010M	223183	Filter Cartridge F010H2	CC1189442	Filter Cartridge F010A2	CC1189434
CHB-AIR 186	Filter Cartridge F018M	223184	Filter Cartridge F018H2	CC1189443	Filter Cartridge F018A2	CC1189435
CHB-AIR 306	Filter Cartridge F030M	223185	Filter Cartridge F030H2	CC1189454	Filter Cartridge F030A2	CC1189437
CHB-AIR 476	Filter Cartridge F047M	223186	Filter Cartridge F047H2	CC1189455	Filter Cartridge F047A2	CC1189438
CHB-AIR 706	Filter Cartridge F070M	223187	Filter Cartridge F070H2	CC1189456	Filter Cartridge F070A2	CC1189439

CHB-AIR PLUS PORTABLE BREATHING AIR FILTRATION SYSTEMS						
FILTER TYPE	ELEMENT TYPE (FM)	ELEMENT NO	ELEMENT TYPE (F-H2M)	ELEMENT NO	ELEMENT TYPE (F-A2)	ELEMENT NO
CHB-AIR plus	Filter Cartridge F007M	223182	Filter Cartridge F007H2	CC1189441	Filter Cartridge F007A2	CC1189354

CH-PP SERIES PAINTING AIR FILTRATION SYSTEMS								
FILTER TYPE	ELEMENT TYPE (FM)	ELEMENT NO	ELEMENT TYPE (F-S)	ELEMENT NO	ELEMENT TYPE (F-A)	ELEMENT NO	ELEMENT TYPE (CKL-PP)	ELEMENT NO
CH-PP-107							Filter Cartridge F007-CKL-PP	CC1189457
CH-PP-110							Filter Cartridge F010-CKL-PP	CC1189458
CH-PP-207	Filter Cartridge F007M	223182					Filter Cartridge F007-CKL-PP	CC1189457
CH-PP-210	Filter Cartridge F010M	223183					Filter Cartridge F010-CKL-PP	CC1189458
CH-PP-307	Filter Cartridge F007M	223182	Filter Cartridge F007S	223192			Filter Cartridge F007-CKL-PP	CC1189457
CH-PP-310	Filter Cartridge F010M	223183	Filter Cartridge F010S	223193			Filter Cartridge F010-CKL-PP	CC1189458
CH-PP-407	Filter Cartridge F007M	223182	Filter Cartridge F007S	223192	Filter Cartridge F007A	223212		
CH-PP-410	Filter Cartridge F010M	223183	Filter Cartridge F010S	223193	Filter Cartridge F010A	223213		
CH-PP-507	Filter Cartridge F007M	223182	Filter Cartridge F007S	223192				
CH-PP-510	Filter Cartridge F010M	223183	Filter Cartridge F010S	223193				
CH-PP-607	Filter Cartridge F007M	223182	Filter Cartridge F007S	223192				
CH-PP-610	Filter Cartridge F010M	223183	Filter Cartridge F010S	223193				

FILTER ELEMENTS MUST BE REPLACED AT LEAST EVERY 12 MONTHS

SERVICE KITS FOR LEGACY PRODUCTS

MODEL	BASIC	STANDARD	ADVANCED
KA2-KA5	CC1089648	CC1089649	CC1089650
KA6	CC1089648	CC1125182	CC1125184
KA7 Plus	CC1089652	CC1125190	CC1125192
KSA11-KSA15	CC1089656	CC1089657	CC1089658
KSA18-KSA22	CC1089661	CC1089662	CC1089663
KSA30	CC1090691	CC1121434	CC1121435
KSA37	-	CC1121437	CC1121438
KSA55-KSA75	CC1154032	CC1154033	CC1154034
KS97	CC1090695	CC1090696	CC1090697
KSV11-KSV15	CC1089656	CC1089657	CC1089658
KSV18-KSV22	CC1089661	CC1089662	CC1089663
KSV30	CC1090691	CC1121434	CC1121435
KSV37-KSV45	-	CC1121437	CC1121438
KSV55-KSV75	CC1154032	CC1154035	CC1154036
KSB15-KSB22	-	CC1178518	CC1180296
KBV15-KBV22	-	CC1178518	CC1180296
KSA90	-	CC1154033	CC1154034
KSV90	-	CC1154035	CC1154036

SALES CONDITIONS & PRICES

Prices are valid for orders received on or after 1st February 2023

Prices shown are in the currency indicated ex-works (Incoterms 2000)
Lonate Pozzolo, Italy with the following exceptions:

- Vane & Portable Compressors
 - EXW Redditch, UK
- Spares Parts
 - EXW Lonate, Italy/
Tongeren, Belgium
- Portables from CMP-P21
upwards and FM90-132
 - EXW Simmern Germany

In the case of a discrepancy in price, the Champion system is the system of record containing the correct price.

Individual quotations and orders are subject to the standard terms and conditions.

The products contained within the price list are manufactured in compliance with EU directives and other national standards.

Champion reserve the right to make changes to the design and execution and accept no liability for errors or misprints.

Champion reserves the right to modify these prices at any time providing 30 days written notification.

Technical details in price book are for reference only and subject to change. For full technical details and in case of discrepancy the technical data sheets contain the correct information.

Contact

orders@championairtech.com
for orders and customer service

sales@championairtech.com
for sales requests and enquiries

service@championairtech.com
for aftermarket requests

customerfeedback@championairtech.com
customer feedback

Website: www.ChampionAirtech.com



COMPRESSED AIR SOLUTIONS

CHAMPION

YOUR COMPRESSED AIR PARTNER



Champion's piston compressor range is designed to cover all the possible professional uses of compressed air. Our piston compressors come in various forms and sizes, providing a truly complete range of choices.



Champion stationary rotary screw compressors, both fixed and variable speed drive, are the answer to the needs of small and medium-sized companies.



A modern production system and process demands increased levels of air quality. Our complete Air Treatment Range ensures product quality and efficient operation.



Champion also design and manufacture an enviable range of Rotary Scroll, Rotary Vane and Portable Rotary Screw compressors. All designed to provide efficiency and reliability in the most demanding applications and conditions, these compressors set new standards.

www.championairtech.com

For additional information please contact your local representative. Specifications subject to change without notice.